

ZKLF2068-2RS-2AP-XL

Axial angular contact ball bearing

Schaeffler ID:
0016447000000

Axial angular contact ball bearings
ZKLF..-2RS-2AP-XL, matched pair, double
direction, lip seals on both sides

X-life

Technical information

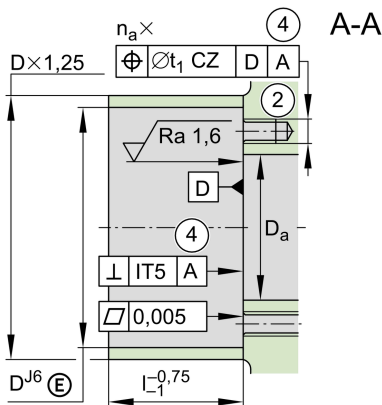
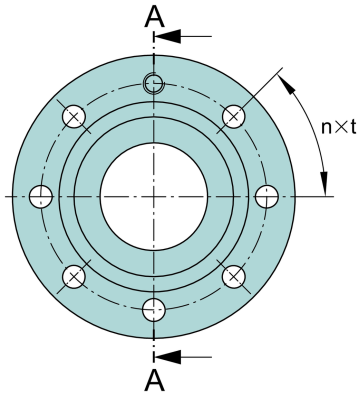
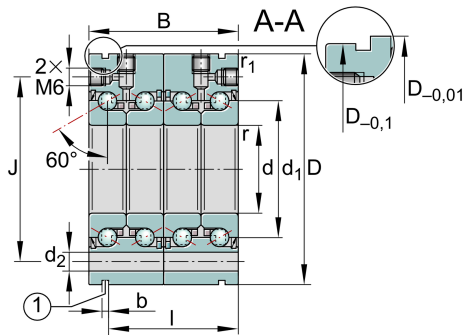

Main Dimensions & Performance Data

d	20 mm	Bore diameter
	0 mm	Bore diameter upper tolerance
	-0,005 mm	Bore diameter lower tolerance
D	68 mm	Outside diameter
	0 mm	Outside diameter upper tolerance
	-0,01 mm	Outside diameter lower tolerance
B	56 mm	Width
	0 mm	Width upper tolerance
	-0,25 mm	Width lower tolerance
C_a	46.000 N	Basic dynamic load rating, axial
C_{0a}	94.000 N	Basic static load rating, axial
C_{ua}	5.700 N	Fatigue load limit, axial
$n_{G \text{ Grease}}$	6.600 1/min	Limiting speed for grease lubrication
n_g	3.000 1/min	Thermally safe operating speed
M_R	0,45 Nm	Bearing frictional torque
$\approx m$	1,14 kg	Weight

Mounting dimensions

$D_{a \text{ max}}$	43 mm	Maximum diameter of housing
$d_{a \text{ min}}$	25 mm	Minimum diameter shaft
t_1	0,1 mm	Position tolerance of bore in the housing
	M6X70	Size of fixing screws
n_a	8	Number of holes in adjacent construction
t_a	45 °	Pitch separation angle of holes in adjacent construction
	M6	Connection thread for lubrication

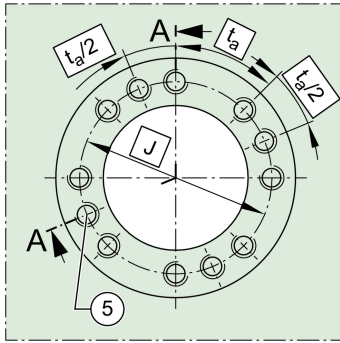
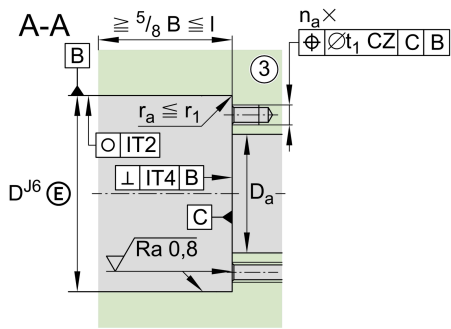

Dimensions

d_1	34,5 mm	Rib diameter inner ring
r_{\min}	0,3 mm	Minimum chamfer dimension
$r_{1 \min}$	0,6 mm	Minimum chamfer dimension
J	53 mm	Pitch circle diameter fixing holes
d_2	6,8 mm	Fixing holes diameter
b	3 mm	Width of extraction slot
l	47 mm	Distance of extraction slot
n	8	Pitch quantity of fixing holes
t	45 °	Pitch separation angle of fixing holes
a	60 °	Contact angle

Temperature range

T_{\min}	-30 °C	Operating temperature min.
T_{\max}	120 °C	Operating temperature max.

Additional information

c_{aL}	1.150 N/μm	Rigidity axial
c_{kL}	320 Nm/mrad	Tilting rigidity
M_m	0,564 kg*cm ²	Mass moment of inertia
	2 μm	Axial runout
	ZMA20/38	Recommended INA precision locknut for radial locking
	AM20	Recommended INA precision locknut for axial locking
M_A	18 Nm	Tightening torque for the recommended INA precision locknut
	8.258 N	Required locknut force axial

