

Two-hand operation
(the plunger and the hand lever are operated separately)

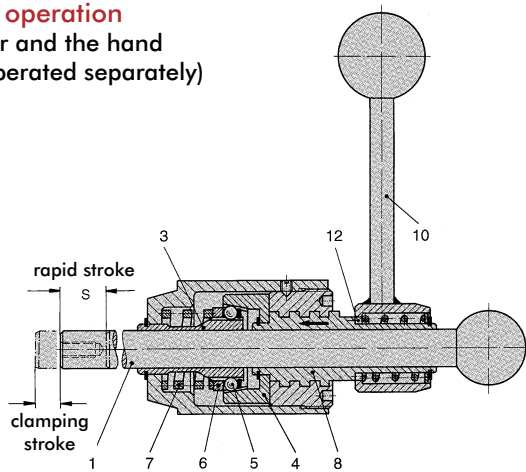

One-hand operation
(the plunger and handle lever/hand wheel are operated simultaneously)

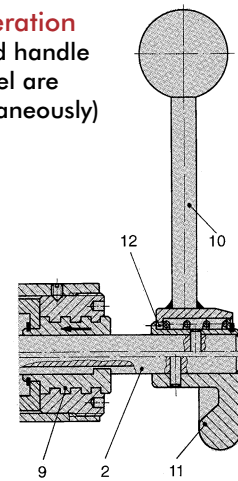

DESTACO's variable stroke Straight Line clamps are used in applications where workpiece thicknesses and workpiece tolerances vary. These clamps are suitable for clamping between ribs and hollow spaces difficult to reach.

Compact design and different types of operation allow for application of the Straight Line clamps in fixtures for mass production as well as for single part production.

Mounting types

- Foot base (FO Series)
- Flange mount (FL Series)
- Through hole mount (G Series)

Type of operation

- Two hand operation
- The hand lever (10) and the plunger (1) are separate. The hand lever is connected to the clamping mechanism. The plunger can be removed from the clamp
- One-hand operation
- The hand lever (10) or the hand wheel (11) and the plunger (2) are linked. The plunger is retained within the clamp.

Clamping operation

The plunger (1) or (2) which is guided within the clamp body contacts the workpiece. By rotating the hand lever (10) or the hand wheel (11) clock-wise the clamping stroke, S1 is engaged and the plunger is tightly gripped by the slotted clamping sleeve (3).

Operating principle

The hand lever's (10) clock-wise rotation causes the threaded sleeve (8) and the conical sleeve (4) to which it is connected to move in the direction of the arrow shown in the drawing. The conical sleeve produces a force-locking connection between the slotted clamping sleeve (3) and the plunger by means of the ball bearings (5) located at the clamping sleeve's perimeter.

Due to the force-locking connection, the plunger rotates and produces the clamping stroke S1. The plungers rotation may be compensated for by means of a swivel hold-down piece.

The clamping strokes S1 specified in this catalog were measured with no opposing forces present while measurements were taken. When clamping this product against a workpiece, the clamping stroke S1 is reduced by the force-locking connection between the plunger and the workpiece. The straight-action clamp is unlocked by turning the hand lever or the hand wheel counter-clockwise. This method is used for both the one-hand and the two-hand operation types. This counter-clockwise rotation makes the conical sleeve (4) and the threaded sleeve (8) or (9) move backward. The pressure spring (7) pushes back the relieved ball bearings (5) via the pressure ring (6).

The force-locking connection between the slotted clamping sleeve and the plunger can be moved freely again. Straight Line clamps which are two-hand operated can also be applied to pull actions when the plunger is inserted in the clamp's housing in the opposite direction. On the one hand operated clamp, the rotation inducing the clamping stroke S1 is directly transmitted from the plunger (2) or the hand wheel to the threaded sleeve (9) via a groove/spring connection. The clamping and unclamping operations are executed in the same way as described before.

Handling

To change the position of the handle while in the clamped or the unclamped position, pull the hand lever off its spline (12) and set it in the desired position.

Important

The holding forces specified in the catalog refer to the maximum load exerted on the clamp by counter-forces. For details concerning the clamping force FS exerted on the workpiece by the clamp and depending on the operation force FB (manual force), please see the chart on the next page.

The clamping force is proportional to the operation force. The achieved clamping force must not exceed the maximum holding force.

As the Straight Line clamps, with the exception of the F-160 model, are designed only for axial load, we recommend to use an additional radial support for the plunger in the event of side load.

FO, FL, G SERIES

Variable Stroke Straight Line Action Clamps | Technical Information

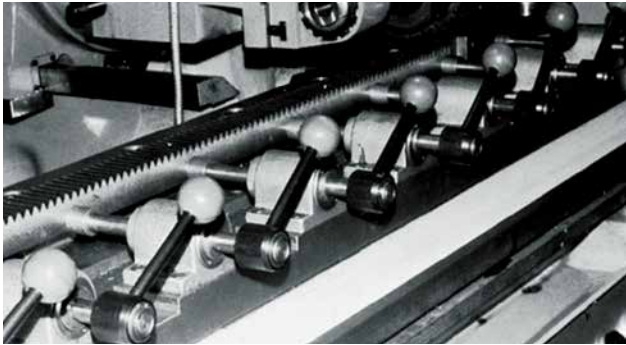

Model FO-161/60 on a milling machine

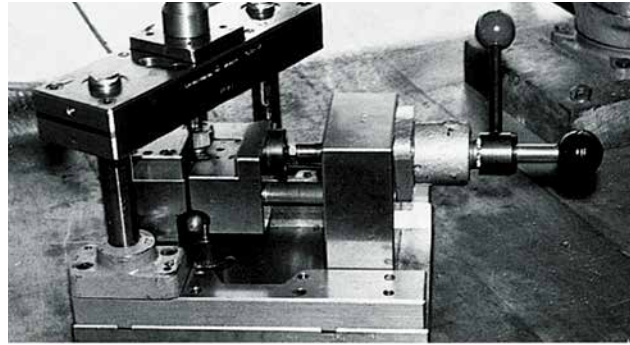

Model FL-160 with plunger 16/100 on a punching fixture

Different Designs



FO Series

Mounting type: flange base foot mount
Operating method: one-hand or two-hand operation

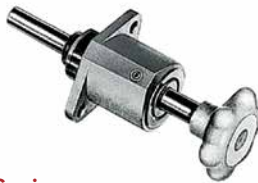

FL Series

Mounting type: front flange mount
Operating method: one-hand or two-hand operation



G Series

Mounting type: through hole mount
Operating method: one-hand or two-hand operation

Mounting type	Operating method			Model	Max. holding capacity [lbs.] N	Clamping force F_s with an operating force F_B		Rapid stroke S [mm]	Max. clamping stroke S1 [mm]	Weight	
	Two-hand operation Plunger and hand lever	One-hand operation Hand lever	One-hand operation Hand wheel			FB [lbs.] N	FS [lbs.] N			[lbs]	Kg
Foot mount	[Foot mount icon]	•		•	FO-082-40	[335] 1500	[22] 100	[100] 450	40	2,5	[0.72] 0,325
		•			FO-120 ¹⁾	[675] 3000		[425] 1900	100, 200, 300	3	[1.19] 0,540
			•		FO-121-45	[675] 3000		[425] 1900	45	3	[1.47] 0,665
	[Foot mount icon]	•			FO-122-45	[675] 3000		[100] 450	40	3	[1.34] 0,610
		•			FO-160 ¹⁾	[2020] 9000		[560] 2500	100, 200, 300	4	[2.73] 1,240
			•		FO-161-60	[2020] 9000		[560] 2500	60	4	[3.40] 1,540
Flange mount	[Flange mount icon]			•	FO-162-60	[2020] 9000	[190] 850	60	4	[3.15] 1,430	
		•			FO-220 ¹⁾	[4045] 18000	[675] 3000	100, 200, 300	4	[5.85] 2,655	
			•		FO-221-80	[4045] 18000	[675] 3000	80	4	[7.46] 3,385	
	[Flange mount icon]	•			FL-120 ¹⁾	[675] 3000	[425] 1900	100, 200, 300	3	[1.07] 0,485	
			•		FL-121-45	[675] 3000	[425] 1900	45	3	[1.34] 0,610	
		•			FL-122-45	[675] 3000	[100] 450	40	3	[1.21] 0,550	
Through hole mount	[Through hole mount icon]			•	FL-160 ¹⁾	[2020] 9000	[560] 2500	100, 200, 300	4	[2.49] 1,130	
			•		FL-161-60	[2020] 9000	[560] 2500	60	4	[3.15] 1,430	
				•	FL-162-60	[2020] 9000	[190] 850	60	4	[2.92] 1,325	
		•			G-082-40	[335] 1500	[100] 450	40	2,5	[0.66] 0,300	
Through hole mount	[Through hole mount icon]	•			G-120 ¹⁾	[675] 3000	[425] 1900	100, 200, 300	3	[1.01] 0,470	
			•		G-121-45	[675] 3000	[425] 1900	45	3	[1.31] 0,595	
				•	G-122-45	[675] 3000	[100] 450	40	3	[1.18] 0,335	

Two-hand operation (the plunger and the hand lever are operated separately)

Through hole mount

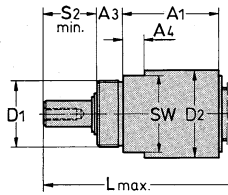

Part no. G-121/45

Flange mount

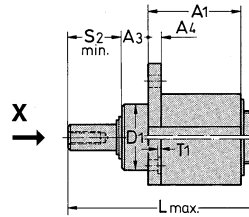

View "X"

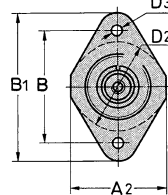

Part no. FL-120/--

View "X"

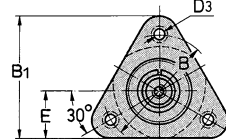

Part no. FL-160/--

Foot mount

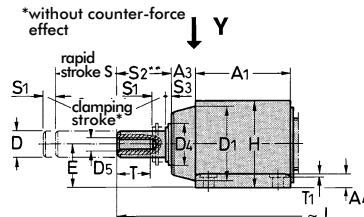

View "Y"

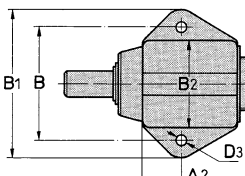

Part no. FO-120/--

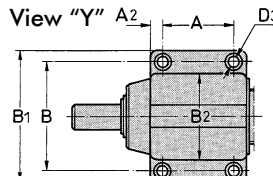

Part no. FO-160/--
FO-220/--

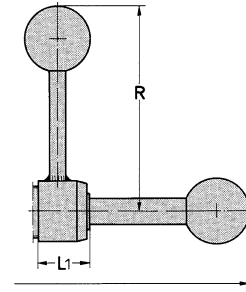

Accessories

(order separately)

Plunger

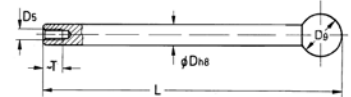

Part no. Ø length	For rapid stroke S	Weight ~ [lbs.] kg	For clamps
12/100	100	[0.30] 0,135	FO-120
12/200	200	[0.62] 0,280	FL-120
12/300	300	[0.82] 0,370	G-120
16/100	100	[0.88] 0,400	FO-160
16/200	200	[1.10] 0,500	FL-160
16/300*	300	[1.54] 0,700	
22/100	100	[2.20] 1,000	
22/200	200	[2.40] 1,090	FO-220
22/300	300	[3.06] 1,390	

*400 and 500 mm lengths available upon request.

Important
The Straight Line clamps are designed only for **axial load**. In case of side load, we recommend an additional radial support of the plunger.

Mounting type	Part no. without plunger	Available rapid strokes S (order plunger separately)	A	A1	A2	A3	A4	A8	B	B1	B2	Dh8	D1	D2	D3	D4
Foot mount	FO-120	100, 200, 300	-	44	19	12	6,3	8,5	52	68	40	12	35	-	6,5	20
	FO-160	100, 200, 300	40	62	11	12	12	10	70	90	52	16	46	-	9	25
	FO-220	100, 200, 300	50	75	13	20	15	12	90	115	69	22	60	-	11	36
Flange mount	FL-120	100, 200, 300	-	44	44	12	6	8,5	52	68	-	12	30f7	40	6,5	20
	FL-160	100, 200, 300	-	60	-	14	14	10	68	73	-	16	40f7	52	9	25
Through hole mount	G-120	100, 200, 300	-	44	-	12	10	8.5	-	-	-	12	M30 x1,5	40	-	20

Mounting type	Part no. without plunger	D5	D6	E	E1	H	~ L L with rapid strokes:			L1	R	S2	S3	SW	SW1	T	T1	T3
							100	200	300									
Foot mount	FO-120	M6	30	20	12,5	42	226	326	426	24	95	2,5	2,5	-	11	12	-	10
	FO-160	M8	35	30	14,8	58	253	353	453	33	130	3	3	-	13	15	1	14
	FO-220	M12	40	35	19,5	71	287	387	487	35	197	3	3	-	17	25	1	18
Flange mount	FL-120	M6	30	-	12,5	-	226	326	426	24	95	2,5	2,5	-	11	12	-	10
	FL-160	M8	35	28	14,8	-	253	353	453	33	130	3	3	-	13	15	1	14
Through hole mount	G-120	M6	30	-	12,5	-	226	326	426	24	95	2,5	2,5	35	11	12	-	12

FO, FL, G SERIES

Variable Stroke Straight Line Action Clamps | Technical Information | Dimensions

One-hand operation (the plunger and the hand wheel are operated simultaneously)

Through hole mount

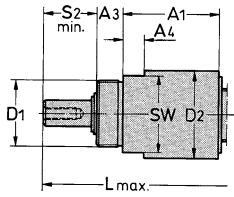

Part no. G-082/40
G-122/45

Flange mount

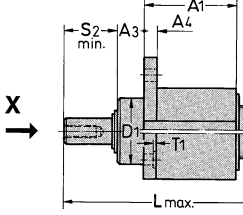

View "X"

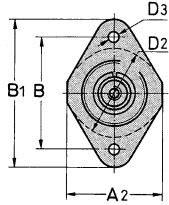

Part no. FL-122/45

View "X"

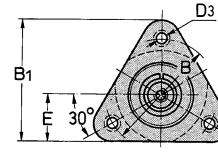

Part no. FL-162/60

Foot mount

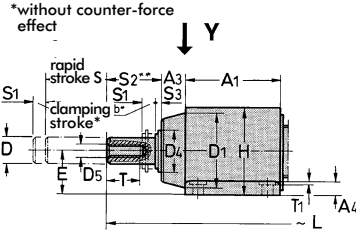

View "Y"

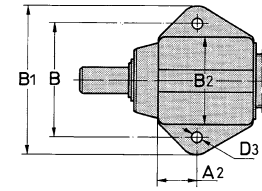

Part no. FO-082/40
FO-122/45

View "Y"

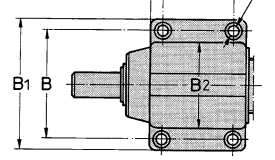

Part no. FO-162/60

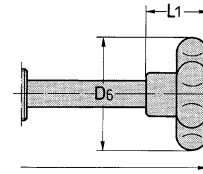

Important

The Straight Line clamps are designed only for **axial load**. In case of side load, we recommend an additional radial support of the plunger.

Mounting type	Part no. with plunger	A	A1	A2	A3	A4	A5	B	B1	B2	Dh8	D1	D2	D3	D4
	FO-082-40	-	37	15,3	10	5	6	44	56	35	8	30	-	4,5	16
	FO-122-45	-	44	19	12	6,3	8,5	52	68	40	12	35	-	6,5	20
	FO-162-60	40	62	11	12	12	10	70	90	52	16	46	-	9	25
	FL-122-45	-	44	44	12	6	85	52	68	-	12	30f7	40	6,5	20
	FL-162-60	-	60	-	14	14	10	68	73	-	16	40f7	52	9	25
	G-082-40	-	37	-	10	8	6	-	-	-	8	M24x1,5	35	-	16
	G-122-45	-	44	-	12	10	8,5	-	-	-	12	M30x1,5	40	-	20

Mounting type	Part no. with plunger	D5	D6	E	E1	H	L	L1	S2	S3	SW	SW1	T	T1	T3
	FO-082-40	M5	40	18	9,2	36	128	26	9	2,5	-	8	8	-	8
	FO-122-45	M6	75	20	12,5	42	153	27	15	2,5	-	11	12	-	10
	FO-162-60	M8	75	30	14,8	58	196	35	18	3	-	13	15	1	14
	FL-122-45	M6	52	-	12,5	-	153	27	15	2,5	-	11	12	-	10
	FL-162-60	M8	75	28	14,8	-	196	35	18	3	-	13	15	1	14
	G-082-40	M5	40	-	9,2	-	128	26	9	2,5	30	8	12	-	8
	G-122-45	M6	52	-	12,5	-	153	27	15	2,5	35	11	12	-	10

One-hand operation (the plunger and the hand lever are operated simultaneously)

Through hole mount

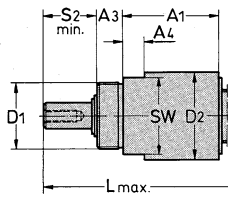

Part no. G-121/45

Flange mount

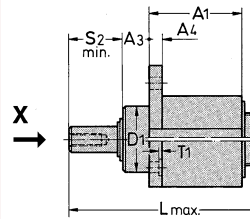

View "X"

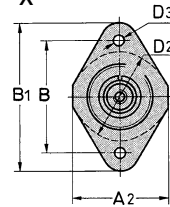

Part no. FL-121/45

View "X"

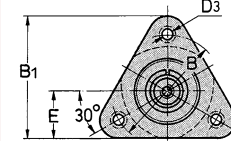

Part no. FL-161/60

Foot mount

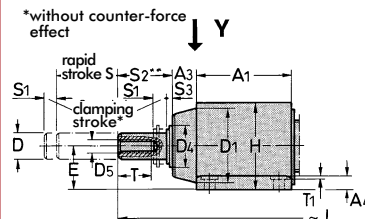

View "Y"

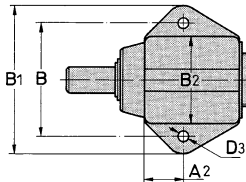

Part no. FO-121/45

View "Y"

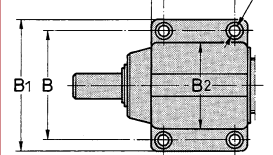

Part no. FO-161/60
FO-221/80

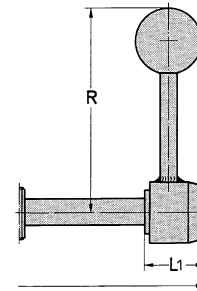

Important

The Straight Line clamps are designed only for **axial load**. In case of side load, we recommend an additional radial support of the plunger.

Mounting type	Part no. with plunger	A	A ₁	A ₂	A ₃	A ₄	A ₅	B	B ₁	B ₂	D _{h8}	D ₁	D ₂	D ₃	D ₄
Foot mount	FO-121-45	-	44	19	12	6,3	8,5	52	68	40	12	35	-	6,5	20
	FO-161-60	40	62	11	12	12	10	70	90	52	16	46	-	9	25
	FO-221-80	50	75	13	20	15	12	90	115	69	22	60	-	11	36
Flange mount	FL-121-45	-	44	44	12	6	8,5	52	68	-	12	30f7	40	6,5	20
	FL-161-60	-	60	-	14	14	10	68	73	-	16	40f7	52	9	25
Through hole mount	G-121-45	-	44	-	12	10	8,5	-	-	-	12	M30x1,5	40	-	20

Mounting type	Part no. with plunger	D ₅	E	E ₁	H	L	L ₁	R	S ₂	S ₃	SW	SW ₁	T	T ₁	T ₃
Foot mount	FO-121-45	M6	20	12,5	42	153	27	95	15	2,5	-	11	12	-	10
	FO-161-60	M8	30	14,8	58	196	35	130	18	3	-	13	15	1	14
	FO-221-80	M12	35	19,5	71	245	40	197	20	3	-	17	25	1	18
Flange mount	FL-121-45	M6	-	12,5	-	153	27	95	15	2,5	-	11	12	-	10
	FL-161-60	M8	28	14,8	-	196	35	130	18	3	-	13	15	1	14
Through hole mount	G-121-45	M6	-	12,5	-	153	27	95	15	2,5	35	11	12	-	10