



## CSXG250

Four-point contact bearing

Schaeffler ID:  
0033211850000

Four point contact bearing, Thin section bearing CSXG, brass sheet metal cage

### Technical information

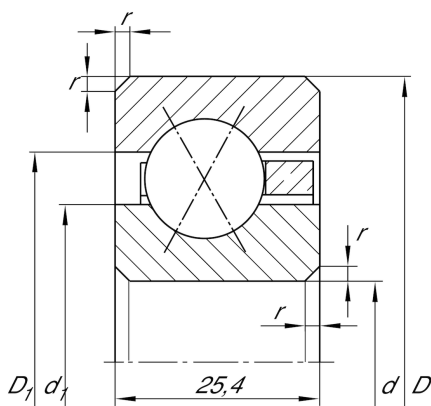

### Main Dimensions & Performance Data

d	635 mm	Bore diameter
D	685,5 mm	Outside diameter
B	25,4 mm	Width
$C_r$	96.000 N	Basic dynamic load rating, radial
$C_{0r}$	300.000 N	Basic static load rating, radial
$n_G$	350 1/min	Limiting speed
$\approx m$	8,83 kg	Weight

### Dimensions

$r_{\min}$	2 mm	Minimum chamfer dimension
$d_1$	653,9 mm	Shoulder diameter inner ring
$D_1$	667 mm	Shoulder diameter outer ring
$\alpha$	30 °	Contact angle

### Temperature range

$T_{\min}$	-30 °C	Operating temperature min.
$T_{\max}$	120 °C	Operating temperature max.