



CSXG160

Four-point contact bearing

Schaeffler ID:
0076028040000

Four point contact bearing, Thin section bearing CSXG, brass sheet metal cage

Technical information

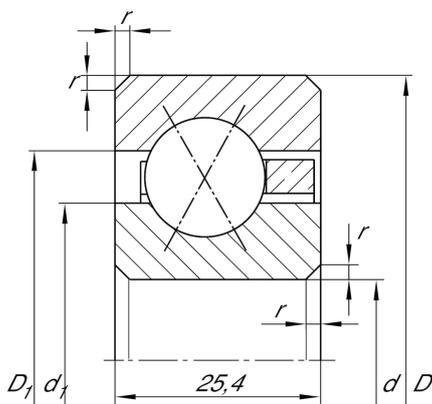

Main Dimensions & Performance Data

d	406,4 mm	Bore diameter
D	457,2 mm	Outside diameter
B	25,4 mm	Width
C_r	82.000 N	Basic dynamic load rating, radial
C_{0r}	195.000 N	Basic static load rating, radial
n_G	580 1/min	Limiting speed
$\approx m$	5,57 kg	Weight

Dimensions

r_{\min}	2 mm	Minimum chamfer dimension
d_1	425,3 mm	Shoulder diameter inner ring
D_1	438,4 mm	Shoulder diameter outer ring
α	30 °	Contact angle

Temperature range

T_{\min}	-30 °C	Operating temperature min.
T_{\max}	120 °C	Operating temperature max.