



CSXF075

Four-point contact bearing

Schaeffler ID:
0031050240000

Four point contact bearing, Thin section bearing CSXF, brass sheet metal cage

Technical information

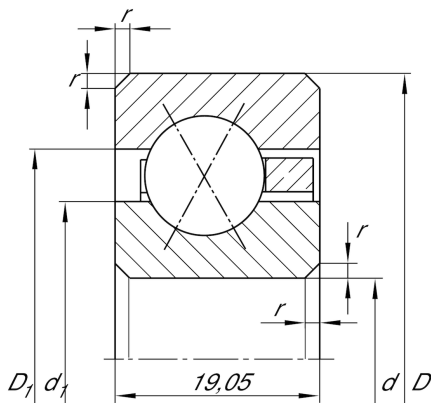

Main Dimensions & Performance Data

d	190,5 mm	Bore diameter
D	228,6 mm	Outside diameter
B	19,05 mm	Width
C_r	39.000 N	Basic dynamic load rating, radial
C_{0r}	64.000 N	Basic static load rating, radial
n_G	1.410 1/min	Limiting speed
$\approx m$	1,54 kg	Weight

Dimensions

r_{\min}	2 mm	Minimum chamfer dimension
d_1	204,6 mm	Shoulder diameter inner ring
D_1	214,5 mm	Shoulder diameter outer ring
α	30 °	Contact angle

Temperature range

T_{\min}	-30 °C	Operating temperature min.
T_{\max}	120 °C	Operating temperature max.