



CSXC045

Four-point contact bearing

Schaeffler ID:
0047768520000

Four point contact bearing, Thin section bearing CSXC, brass sheet metal cage

Technical information

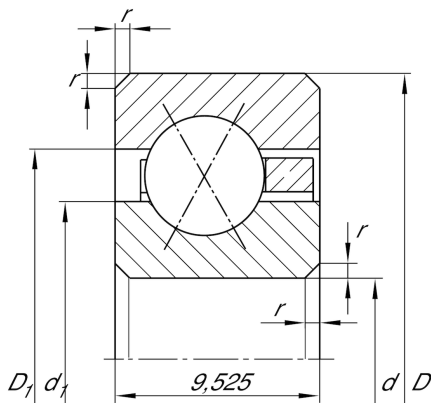

Main Dimensions & Performance Data

d	114,3 mm	Bore diameter
D	133,35 mm	Outside diameter
B	9,525 mm	Width
C_r	10.800 N	Basic dynamic load rating, radial
C_{0r}	16.100 N	Basic static load rating, radial
n_G	2.750 1/min	Limiting speed
$\approx m$	220 g	Weight

Dimensions

r_{\min}	1 mm	Minimum chamfer dimension
d_1	121,3 mm	Shoulder diameter inner ring
D_1	126,3 mm	Shoulder diameter outer ring
α	30 °	Contact angle

Temperature range

T_{\min}	-30 °C	Operating temperature min.
T_{\max}	120 °C	Operating temperature max.