



CSXB040

Four-point contact bearing

Schaeffler ID:
0037292730000

Four point contact bearing, Thin section bearing CSXB, brass sheet metal cage

Technical information

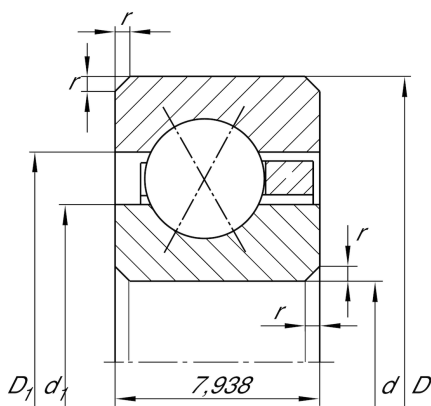

Main Dimensions & Performance Data

d	101,6 mm	Bore diameter
D	117,475 mm	Outside diameter
B	7,938 mm	Width
C _r	8.100 N	Basic dynamic load rating, radial
C _{0r}	12.100 N	Basic static load rating, radial
n _G	3.200 1/min	Limiting speed
≈m	130 g	Weight

Dimensions

r _{min}	1 mm	Minimum chamfer dimension
d ₁	107,5 mm	Shoulder diameter inner ring
D ₁	111,6 mm	Shoulder diameter outer ring
α	30 °	Contact angle

Temperature range

T _{min}	-30 °C	Operating temperature min.
T _{max}	120 °C	Operating temperature max.