



## CSXA055

Four-point contact bearing

Schaeffler ID:  
0073611220000

Four point contact bearing, Thin section bearing CSXA, brass sheet metal cage

### Technical information

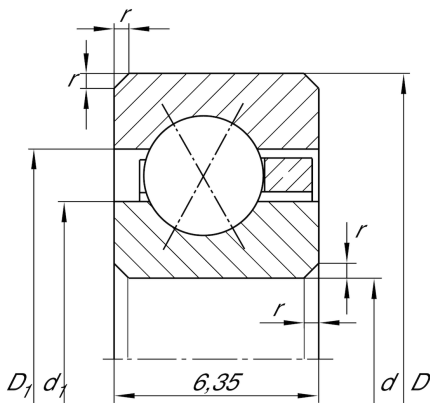

#### Main Dimensions & Performance Data

d	139,7 mm	Bore diameter
D	152,4 mm	Outside diameter
B	6,35 mm	Width
$C_r$	6.300 N	Basic dynamic load rating, radial
$C_{0r}$	12.300 N	Basic static load rating, radial
$n_G$	2.290 1/min	Limiting speed
$\approx m$	110 g	Weight

#### Dimensions

$r_{\min}$	0,6 mm	Minimum chamfer dimension
$d_1$	144,4 mm	Shoulder diameter inner ring
$D_1$	147,7 mm	Shoulder diameter outer ring
$\alpha$	30 °	Contact angle

#### Temperature range

$T_{\min}$	-30 °C	Operating temperature min.
$T_{\max}$	120 °C	Operating temperature max.