



CSXA035

Four-point contact bearing

Schaeffler ID:
0034366080000

Four point contact bearing, Thin section bearing CSXA, brass sheet metal cage

Technical information

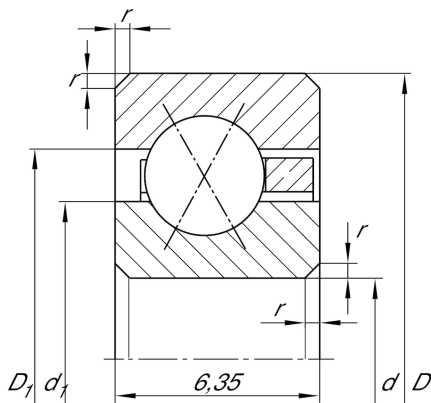

Main Dimensions & Performance Data

d	88,9 mm	Bore diameter
D	101,6 mm	Outside diameter
B	6,35 mm	Width
C_r	5.300 N	Basic dynamic load rating, radial
C_{0r}	7.900 N	Basic static load rating, radial
n_G	3.850 1/min	Limiting speed
$\approx m$	80 g	Weight

Dimensions

r_{\min}	0,6 mm	Minimum chamfer dimension
d_1	93,6 mm	Shoulder diameter inner ring
D_1	96,9 mm	Shoulder diameter outer ring
α	30 °	Contact angle

Temperature range

T_{\min}	-30 °C	Operating temperature min.
T_{\max}	120 °C	Operating temperature max.