



CSEF120

Angular contact ball bearing

Schaeffler ID:
0058227180000

Angular contact ball bearing, Thin section
bearing CSEF, brass sheet metal cage

Technical information

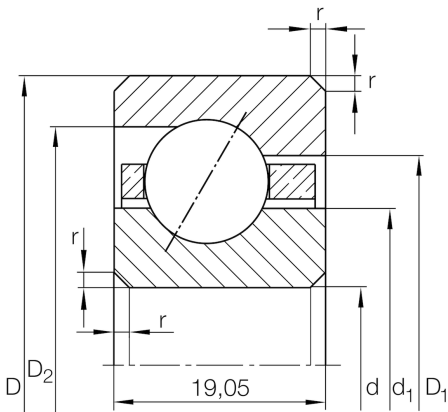

Main Dimensions & Performance Data

d	304,8 mm	Bore diameter
D	342,9 mm	Outside diameter
B	19,05 mm	Width
C_r	35.000 N	Basic dynamic load rating, radial
C_{0r}	69.000 N	Basic static load rating, radial
n_G	1.660 1/min	Limiting speed
$\approx m$	2,36 kg	Weight

Dimensions

r_{\min}	2 mm	Minimum chamfer dimension
d_1	318,9 mm	Shoulder diameter inner ring
D_1	328,8 mm	Shoulder diameter on outer ring wide side face
D_2	332,8 mm	Shoulder diameter on outer ring small side face
α	30 °	Contact angle

Temperature range

T_{\min}	-30 °C	Operating temperature min.
T_{\max}	120 °C	Operating temperature max.