



CSEC045

Angular contact ball bearing

Schaeffler ID:
0097341630000

Angular contact ball bearing, Thin section
bearing CSEC, brass sheet metal cage

Technical information

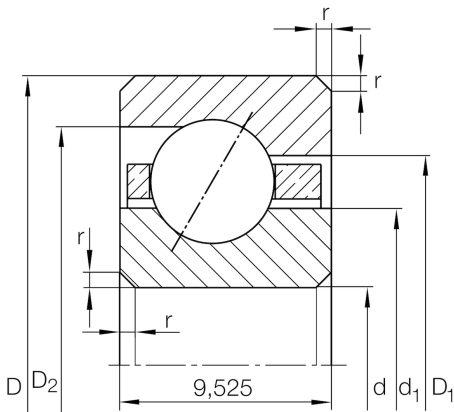

Main Dimensions & Performance Data

d	114,3 mm	Bore diameter
D	133,35 mm	Outside diameter
B	9,525 mm	Width
C_r	8.400 N	Basic dynamic load rating, radial
C_{0r}	11.400 N	Basic static load rating, radial
n_G	4.650 1/min	Limiting speed
$\approx m$	220 g	Weight

Dimensions

r_{\min}	1 mm	Minimum chamfer dimension
d_1	121,3 mm	Shoulder diameter inner ring
D_1	126,3 mm	Shoulder diameter on outer ring wide side face
D_2	128,3 mm	Shoulder diameter on outer ring small side face
α	30 °	Contact angle

Temperature range

T_{\min}	-30 °C	Operating temperature min.
T_{\max}	120 °C	Operating temperature max.