



## CSEB035

Angular contact ball bearing

Schaeffler ID:  
0092996700000

Angular contact ball bearing, Thin section  
bearing CSEB, brass sheet metal cage

### Technical information

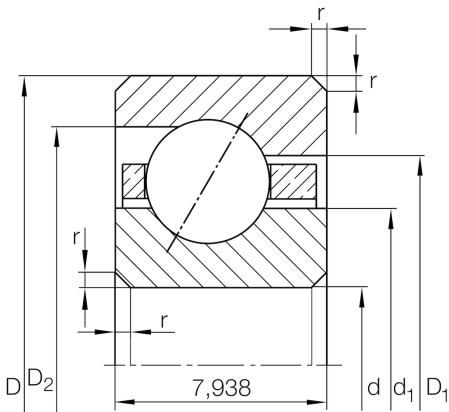

### Main Dimensions & Performance Data

d	88,9 mm	Bore diameter
D	104,775 mm	Outside diameter
B	7,938 mm	Width
$C_r$	5.800 N	Basic dynamic load rating, radial
$C_{0r}$	7.100 N	Basic static load rating, radial
$n_G$	6.000 1/min	Limiting speed
$\approx m$	120 g	Weight

### Dimensions

$r_{\min}$	1 mm	Minimum chamfer dimension
$d_1$	94,8 mm	Shoulder diameter inner ring
$D_1$	98,9 mm	Shoulder diameter on outer ring wide side face
$D_2$	100,6 mm	Shoulder diameter on outer ring small side face
$\alpha$	30 °	Contact angle

### Temperature range

$T_{\min}$	-30 °C	Operating temperature min.
$T_{\max}$	120 °C	Operating temperature max.