



CSEA025

Angular contact ball bearing

Schaeffler ID:
0039951270000

Angular contact ball bearing, Thin section
bearing CSEA, brass sheet metal cage

Technical information

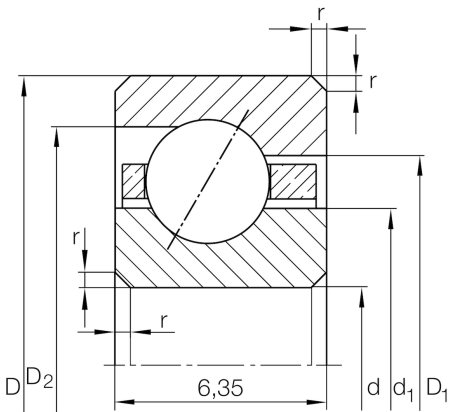

Main Dimensions & Performance Data

d	63,5 mm	Bore diameter
D	76,2 mm	Outside diameter
B	6,35 mm	Width
C_r	3.550 N	Basic dynamic load rating, radial
C_{0r}	3.800 N	Basic static load rating, radial
n_G	8.500 1/min	Limiting speed
$\approx m$	60 g	Weight

Dimensions

r_{\min}	0,6 mm	Minimum chamfer dimension
d_1	68,2 mm	Shoulder diameter inner ring
D_1	71,5 mm	Shoulder diameter on outer ring wide side face
D_2	72,9 mm	Shoulder diameter on outer ring small side face
α	30 °	Contact angle

Temperature range

T_{\min}	-30 °C	Operating temperature min.
T_{\max}	120 °C	Operating temperature max.