



## CSEA020

Angular contact ball bearing

Schaeffler ID:  
0077299010000

Angular contact ball bearing, Thin section  
bearing CSEA, brass sheet metal cage

### Technical information

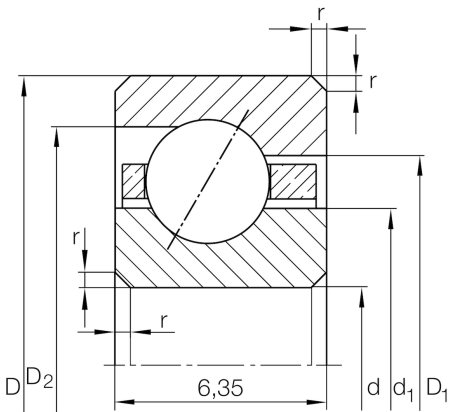

### Main Dimensions & Performance Data

d	50,8 mm	Bore diameter
D	63,5 mm	Outside diameter
B	6,35 mm	Width
$C_r$	3.300 N	Basic dynamic load rating, radial
$C_{0r}$	3.100 N	Basic static load rating, radial
$n_G$	10.500 1/min	Limiting speed
$\approx m$	50 g	Weight

### Dimensions

$r_{\min}$	0,6 mm	Minimum chamfer dimension
$d_1$	55,5 mm	Shoulder diameter inner ring
$D_1$	58,8 mm	Shoulder diameter on outer ring wide side face
$D_2$	60,2 mm	Shoulder diameter on outer ring small side face
$\alpha$	30 °	Contact angle

### Temperature range

$T_{\min}$	-30 °C	Operating temperature min.
$T_{\max}$	120 °C	Operating temperature max.