



CSCU065-2RS

Deep groove ball bearing

Schaeffler ID:
0077199140000

Deep groove ball bearing, Thin section bearing CSCU..-2RS, seals, brass sheet metal cage

Technical information

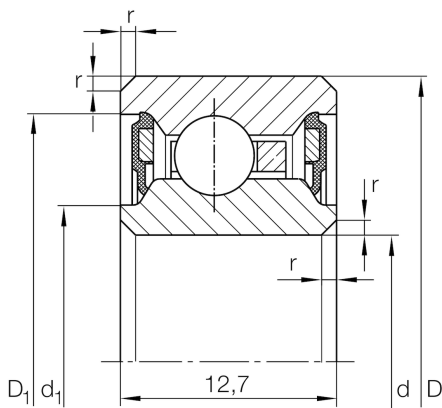

Main Dimensions & Performance Data

d	165,1 mm	Bore diameter
D	184,15 mm	Outside diameter
B	12,7 mm	Width
C _r	9.300 N	Basic dynamic load rating, radial
C _{0r}	13.200 N	Basic static load rating, radial
n _G	1.570 1/min	Limiting speed
≈m	390 g	Weight

Dimensions

r _{min}	0,38 mm	Minimum chamfer dimension
d ₁	168,9 mm	Caliber diameter inner ring
D ₁	178,7 mm	Caliber diameter outer ring

Temperature range

T _{min}	-25 °C	Operating temperature min.
T _{max}	120 °C	Operating temperature max.