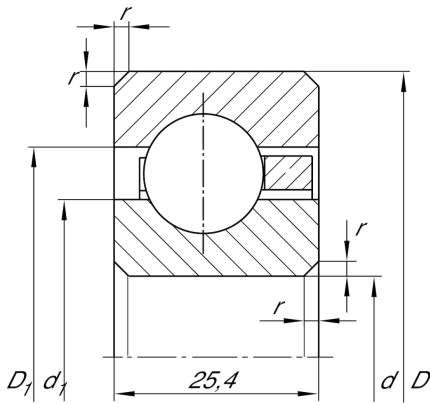

**CSCG200**

Deep groove ball bearing

Deep groove ball bearing, Thin section bearing CSCG, brass sheet metal cage

Technical information

**Main Dimensions & Performance Data**

d	508 mm	Bore diameter
D	558,8 mm	Outside diameter
B	25,4 mm	Width
C _r	63.000 N	Basic dynamic load rating, radial
C _{0r}	139.000 N	Basic static load rating, radial
n _G	970 1/min	Limiting speed
≈m	7,16 kg	Weight

Dimensions

r _{min}	2 mm	Minimum chamfer dimension
d ₁	526,9 mm	Shoulder diameter inner ring
D ₁	540 mm	Shoulder diameter outer ring

Temperature range

T _{min}	-30 °C	Operating temperature min.
T _{max}	120 °C	Operating temperature max.