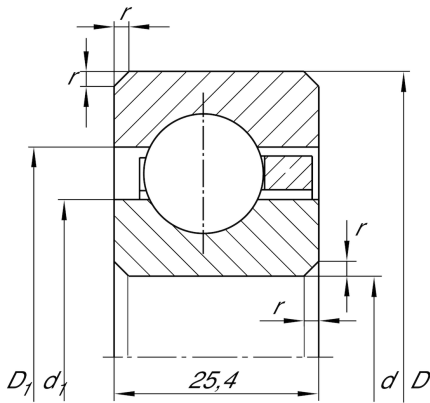

**CSCG075**

Deep groove ball bearing

Deep groove ball bearing, Thin section bearing CSCG, brass sheet metal cage

Technical information

**Main Dimensions & Performance Data**

d	190,5 mm	Bore diameter
D	241,3 mm	Outside diameter
B	25,4 mm	Width
C _r	46.500 N	Basic dynamic load rating, radial
C _{0r}	53.000 N	Basic static load rating, radial
n _G	2.450 1/min	Limiting speed
≈m	2,77 kg	Weight

Dimensions

r _{min}	2 mm	Minimum chamfer dimension
d ₁	209,4 mm	Shoulder diameter inner ring
D ₁	222,5 mm	Shoulder diameter outer ring

Temperature range

T _{min}	-30 °C	Operating temperature min.
T _{max}	120 °C	Operating temperature max.