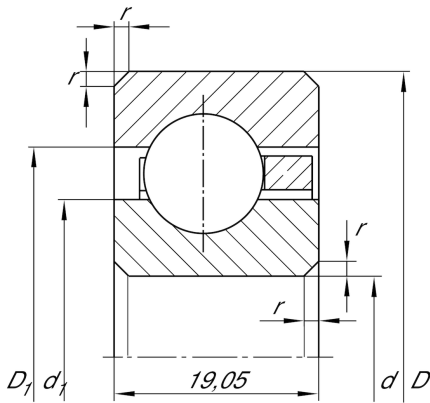

**CSCF110** [↗](#)

Deep groove ball bearing

Deep groove ball bearing, Thin section bearing CSCF, brass sheet metal cage

Technical information

**Main Dimensions & Performance Data**

d	279,4 mm	Bore diameter
D	317,5 mm	Outside diameter
B	19,05 mm	Width
C _r	33.500 N	Basic dynamic load rating, radial
C _{0r}	53.000 N	Basic static load rating, radial
n _G	1.800 1/min	Limiting speed
≈m	2,18 kg	Weight

Dimensions

r _{min}	2 mm	Minimum chamfer dimension
d ₁	293,5 mm	Shoulder diameter inner ring
D ₁	303,4 mm	Shoulder diameter outer ring

Temperature range

T _{min}	-30 °C	Operating temperature min.
T _{max}	120 °C	Operating temperature max.