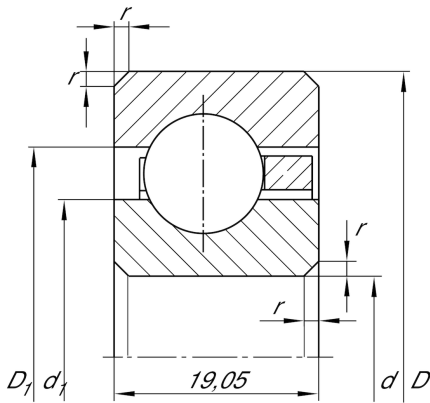

**CSCF090** [↗](#)

Deep groove ball bearing

Deep groove ball bearing, Thin section bearing CSCF, brass sheet metal cage

Technical information

**Main Dimensions & Performance Data**

d	228,6 mm	Bore diameter
D	266,7 mm	Outside diameter
B	19,05 mm	Width
C _r	31.500 N	Basic dynamic load rating, radial
C _{0r}	43.500 N	Basic static load rating, radial
n _G	2.180 1/min	Limiting speed
≈m	1,77 kg	Weight

Dimensions

r _{min}	2 mm	Minimum chamfer dimension
d ₁	242,7 mm	Shoulder diameter inner ring
D ₁	252,6 mm	Shoulder diameter outer ring

Temperature range

T _{min}	-30 °C	Operating temperature min.
T _{max}	120 °C	Operating temperature max.