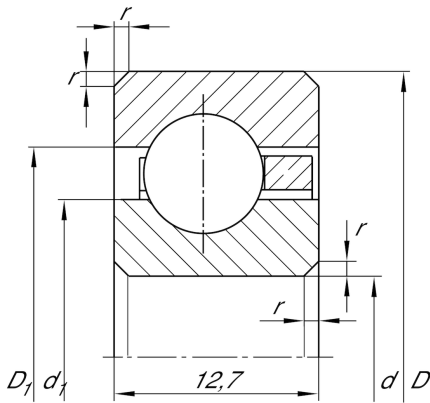

**CSCD070**

Deep groove ball bearing

Deep groove ball bearing, Thin section bearing CSCD, brass sheet metal cage

## Technical information

**Main Dimensions & Performance Data**

d	177,8 mm	Bore diameter
D	203,2 mm	Outside diameter
B	12,7 mm	Width
C <sub>r</sub>	15.000 N	Basic dynamic load rating, radial
C <sub>0r</sub>	20.400 N	Basic static load rating, radial
n <sub>G</sub>	2.900 1/min	Limiting speed
≈m	0,59 kg	Weight

**Dimensions**

r <sub>min</sub>	1,5 mm	Minimum chamfer dimension
d <sub>1</sub>	187,2 mm	Shoulder diameter inner ring
D <sub>1</sub>	193,8 mm	Shoulder diameter outer ring

**Temperature range**

T <sub>min</sub>	-30 °C	Operating temperature min.
T <sub>max</sub>	120 °C	Operating temperature max.