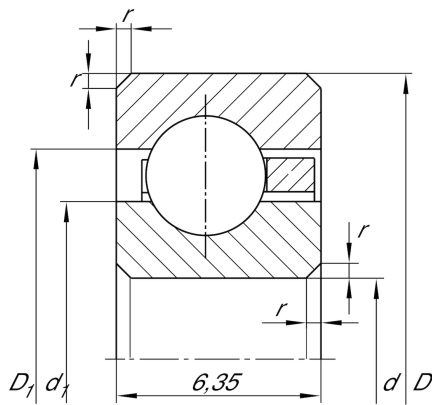

**CSCA080**

Deep groove ball bearing

Deep groove ball bearing, Thin section bearing CSCA, brass sheet metal cage

Technical information

**Main Dimensions & Performance Data**

d	203,2 mm	Bore diameter
D	215,9 mm	Outside diameter
B	6,35 mm	Width
C _r	5.400 N	Basic dynamic load rating, radial
C _{0r}	10.200 N	Basic static load rating, radial
n _G	2.700 1/min	Limiting speed
≈m	170 g	Weight

Dimensions

r _{min}	0,6 mm	Minimum chamfer dimension
d ₁	207,9 mm	Shoulder diameter inner ring
D ₁	211,2 mm	Shoulder diameter outer ring

Temperature range

T _{min}	-30 °C	Operating temperature min.
T _{max}	120 °C	Operating temperature max.