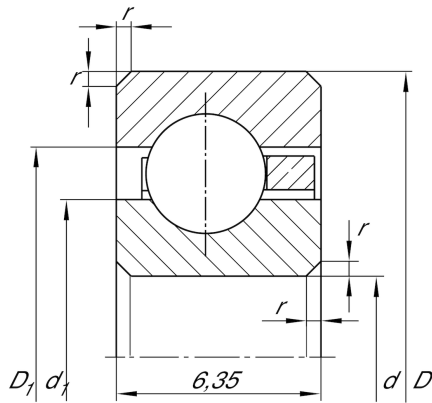

**CSCA040**

Deep groove ball bearing

Deep groove ball bearing, Thin section bearing CSCA, brass sheet metal cage

Technical information

**Main Dimensions & Performance Data**

d	101,6 mm	Bore diameter
D	114,3 mm	Outside diameter
B	6,35 mm	Width
C _r	4.200 N	Basic dynamic load rating, radial
C _{0r}	5.200 N	Basic static load rating, radial
n _G	5.400 1/min	Limiting speed
≈m	90 g	Weight

Dimensions

r _{min}	0,6 mm	Minimum chamfer dimension
d ₁	106,3 mm	Shoulder diameter inner ring
D ₁	109,6 mm	Shoulder diameter outer ring

Temperature range

T _{min}	-30 °C	Operating temperature min.
T _{max}	120 °C	Operating temperature max.