

# 847 SERIES

## Pneumatic Toggle Clamps | Product Overview

### Features:

- Pneumatic version of Series 247 manual clamps
- Switch ready for Ø4mm or 6,5mmX5mm sensors
- Built-in flow restriction eliminates need for external flow controls

### Applications:

- Assembly
- Welding

### Also Available:

See page MC-ACC-1 for spindle accessories

See page MC-PSC-38 for sensing options

847-U



847-S



## Technical Information | Holding Capacities

Model	Maximum Holding Capacity		Max. Exerting Force @ 5bar [72PSI]		Accessories (Supplied)						
	Inner	Outer	Inner	Outer	Weight	Bore Size	Air Consumption† dm <sup>3</sup> [ft <sup>3</sup> ]	Port Size	Spindle Accessory	Flanged Washers	Bolt Retainer
847-U	[1000 lbf] 4450 N	[480 lbf] 2135 N	[948 lbf] 4248 N	[450 lbf] 2018 N	[8.93lb] 4,05kg	[1.97] 50	[0.044] 1,25	1/4 NPT	--	247109	--
847-S	[1000 lbf] 4450 N	[650 lbf] 2890 N		[426 lbf] 1912 N				1/4 NPT	--	--	247110

†Per double stroke at 5bar [72PSI]

**Max Cylinder Pressure:** 10bar [145psig]\*

**Max Operating Temp:** -10°C to 90°C [-14°F to 194°F]

**Replacement Seal Kit:** 847450-50-1-00

**Replacement Clamp Assembly:** 847-U-LC, 847-S-LC

**Replacement Cylinder Assembly:** 847CYL

\*In no case should the inlet pressure be high enough to create an exerting force that exceeds the clamp's holding capacity. See Technical Appendix Section for details.

### Sensor Accessories

Round Reed Switch with Quick Disconnect

T-slot Reed Switch with Quick Disconnect

Quick Disconnect 2M Extension Cable

Quick Disconnect 5M Extension Cable

### Item Number

810169

8EA-109-1

CABL-010

CABL-013

See Pneumatic Accessories section for more options

# 847 SERIES

## Pneumatic Toggle Clamps | Dimensions

847-U

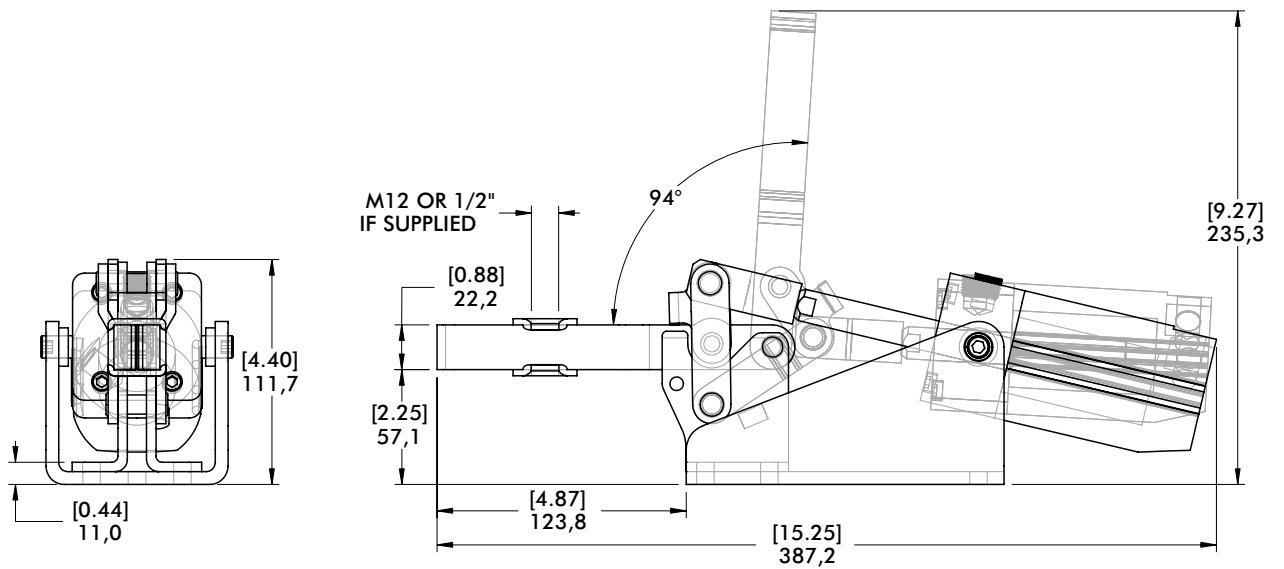
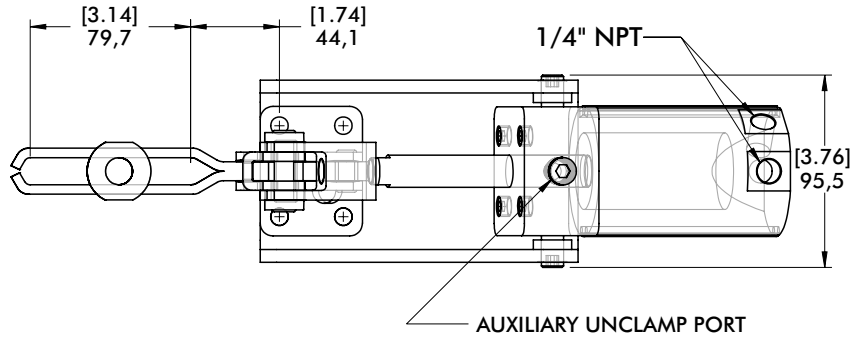

847-S

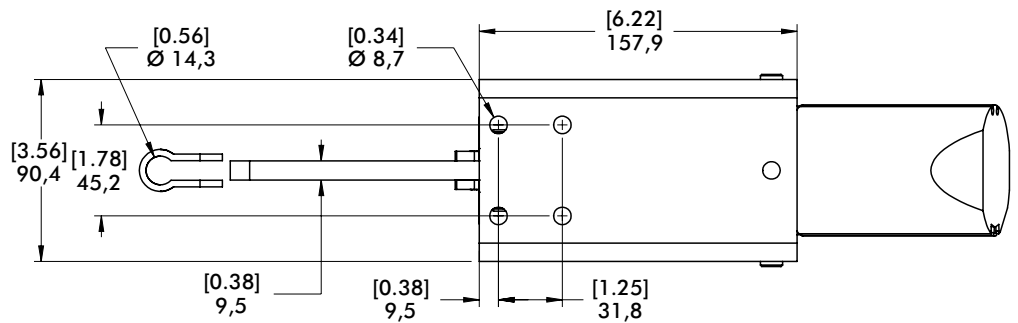

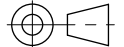
mm [INCH]  
  
 THIRD ANGLE  
 PROJECTION