

817, 827 SERIES

Pneumatic Toggle Clamps | Product Overview

Features:

- Dual mounting surfaces for maximum flexibility
- Sensor ready for round or T-slot style sensors
- Built-in flow restriction eliminates need for external flow controls

Applications:

- Assembly
- Welding

Also Available:

See page MC-ACC-1 for spindle accessories
See page MC-PSC-38 for sensing options

817-U
817-UE



817-S
817-SE



827-U
827-UE



827-S
827-SE



Technical Information | Holding Capacities

Model	Maximum Holding Capacity		Max. Exerting Force @ 5bar [72PSI]		Weight	Bore Size	Air Consumption† dm³ [ft³]	Port Size	Accessories (Supplied)		
	Inner	Outer	Inner	Outer					Spindle Accessory	Flanged Washers	Bolt Retainer
817-U	[375 lbf] 1670 N		[369 lbf] 1648 N					1/8NPT	--	507107	--
817-UE		[200 lbf] 890 N		[225 lbf] 1005 N	1,05kg [2.31lb]	[1.26] 32	[0.015] 0,42	G-1/8	225208-M		
817-S	[450 lbf] 2000 N		[360 lbf] 1608 N					1/8 NPT	--	--	207107
817-SE								G-1/8			
827-U	[600 lbf] 2670 N	[390 lbf] 1735 N		[309 lbf] 1383 N				1/8 NPT	--	235106	--
827-UE			[491 lbf] 2200 N		2,14kg [4.71lb]	[1.57] 40	[0.029] 0,83	G-1/8	240208-M		
827-S	[700 lbf] 3110 N	[330 lbf] 1470 N		[281 lbf] 1257 N				1/8 NPT	--	--	210114
827-SE								G-1/8			

†Per double stroke at 5bar [72PSI]

Max Cylinder Pressure: 10bar [145psig]*

Max Operating Temp: -10°C to 90°C [-14°F to 194°F]

Replacement Seal Kit: 817: 802450-32-1-00
827: 810450-40-1-00

Replacement Clamp Assembly: 817-U-LC, 817-S-LC, 827-U-LC, 827-S-LC

Replacement Cylinder Assembly: 817: 807CYL, 827: 810CYL

*In no case should the inlet pressure be high enough to create an exerting force that exceeds the clamp's holding capacity. See Technical Appendix Section for details.

Sensor Accessories

	Item Number
Round Reed Switch with Quick Disconnect	810169
T-slot Reed Switch with Quick Disconnect	8EA-109-1
Quick Disconnect 2M Extension Cable	CABL-010
Quick Disconnect 5M Extension Cable	CABL-013

See Pneumatic Accessories section for more options

817, 827 SERIES

Pneumatic Toggle Clamps | Dimensions | -U/-UE/-S/-SE

817-U
817-UE



817-U / 817-S / 827-U / 827-S 1/8" NPT
817-UE / 817-SE / 827-UE / 827-SE G-1/8

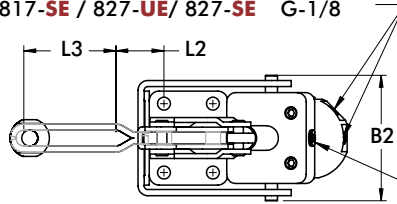

AUXILIARY UNCLAMP PORT
(817-U, 817-S, 827-U, 827-S ONLY)

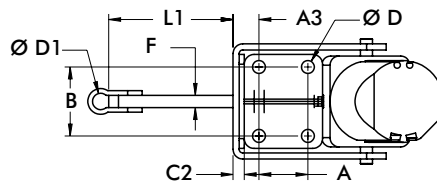
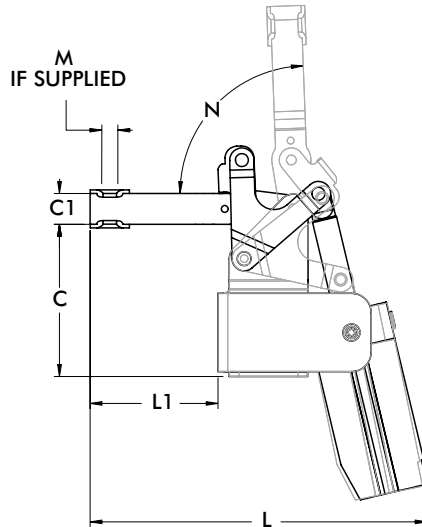
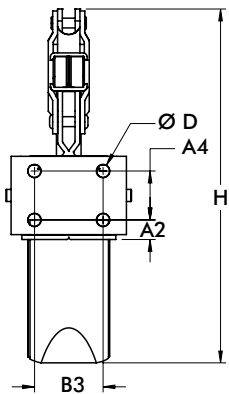

mm [INCH]
THIRD ANGLE
PROJECTION

Mounting Options:

Use two bolts in the "side" mounting holes, to secure mounting bracket, when "top" mounting.

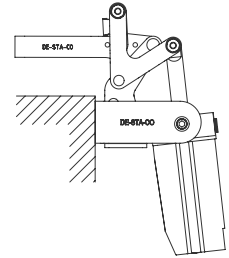
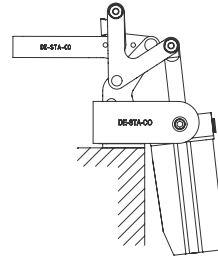
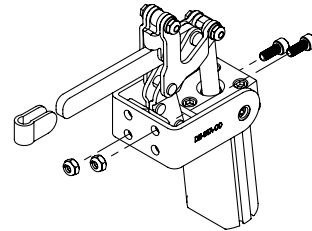

Top Mounting

Side Mounting

Model	A	A2	A3	A4	B	B2	B3	C	C1	C2	C3	C4
817-U												
817-UE	[0.63]	[0.44]	[0.60]	[0.63]	[1.00]	[2.44]	[1.00]	[2.69]	[0.63]	[0.12]	[1.25]	[1.31]
817-S	16	11,2	15,1	16	25,4	62	25,4	68,3	16	3,1	31,8	33,3
817-SE												
827-U								[3.89]	[0.79]			[1.76]
827-UE	[1.25]	[0.51]	[0.66]	[1.25]	[1.75]	[3.08]	[1.75]	98,8	20	[0.12]	[2.00]	44,8
827-S	31,8	12,8	16,8	31,8	44,45	78,3	44,45	[3.91]	[0.75]	3,1	50,8	[1.78]
827-SE								99,2	19,1			45,3

Model	ØD	ØD1	F	H	L	L1	L2	L3	M	N
817-U					[6.24]	[2.37]	[0.19]	[1.90]		
817-UE	[0.27]	-	-	[7.51]	158,6	60,3	4,8	48,4	5/16	90°
817-S	6,7	[0.34]	[0.25]	190,7	[6.97]	[3.04]	-	-	M8	
817-SE		8,7	6,4		175,5	77,2				
827-U					[8.61]	[3.27]	[1.23]	[2.35]		
827-UE	[0.33]	-	-	[9.04]	218,7	83,1	31,2	59,7	3/8	88°
827-S	8,4	[0.42]	[0.31]	229,7	[8.49]	[3.18]	-	-	M10	
827-SE		10,7	7,9		215,6	80,7				