**FAG****53317**

Axial deep groove ball bearing

Axial deep groove ball bearing 533, single direction, with spherical housing washer, steel sheet metal cage

Technical information

Main Dimensions & Performance Data

d	85 mm	Inner diameter shaft washer
D	150 mm	Outer diameter housing washer
T	53,1 mm	Height
C_a	186.000 N	Basic dynamic load rating, axial
C_{0a}	420.000 N	Basic static load rating, axial
C_{ua}	17.700 N	Fatigue load limit, axial
n_G	2.260 1/min	Limiting speed
n_{gr}	4.250 1/min	Reference speed
$\approx m$	3,425 kg	Weight

Mounting dimensions

$d_{a \min}$	124 mm	Minimum diameter shaft shoulder
$D_{a \max}$	115 mm	Maximum diameter of housing shoulder
$r_{a \max}$	1,5 mm	Maximum filled radius

Dimensions

r_{\min}	1,5 mm	Minimum chamfer dimension
D_1	88 mm	Inner diameter housing washer
d_1	150 mm	Outer diameter shaft washer
R	112 mm	Radius spherical housing washer
A	43 mm	Distance of the center point
T_1	58 mm	Height with seat washer

Temperature range

T_{\min}	-30 °C	Operating temperature min.
T_{\max}	150 °C	Operating temperature max.

Calculation factors

A	1,1	Minimum load factor
---	-----	---------------------

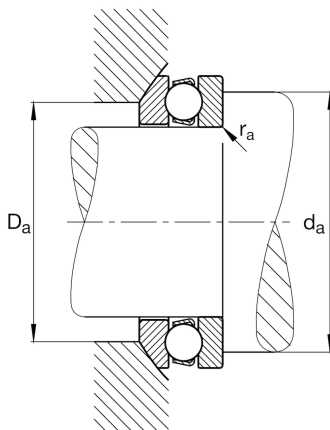
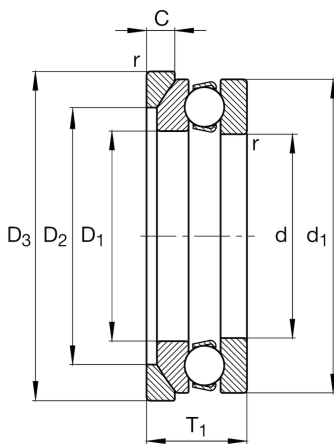
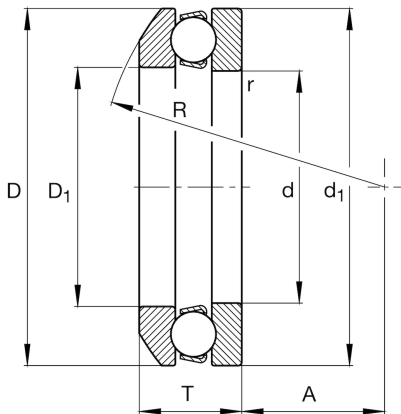



View product details on medias

19.04.2024, 17:07:46 CEST

SCHAEFFLER

Additional information

U317

Seat washer

