**FAG****53312**

Axial deep groove ball bearing

Axial deep groove ball bearing 533, single direction, with spherical housing washer, steel sheet metal cage

## Technical information

## Main Dimensions &amp; Performance Data

d	60 mm	Inner diameter shaft washer
D	110 mm	Outer diameter housing washer
T	38,3 mm	Height
$C_a$	101.000 N	Basic dynamic load rating, axial
$C_{0a}$	207.000 N	Basic static load rating, axial
$C_{ua}$	9.500 N	Fatigue load limit, axial
$n_G$	3.150 1/min	Limiting speed
$n_{gr}$	5.700 1/min	Reference speed
$\approx m$	1,372 kg	Weight

## Mounting dimensions

$d_{a \min}$	90 mm	Minimum diameter shaft shoulder
$D_{a \max}$	85 mm	Maximum diameter of housing shoulder
$r_{a \max}$	1 mm	Maximum filled radius

## Dimensions

$r_{\min}$	1,1 mm	Minimum chamfer dimension
$D_1$	62 mm	Inner diameter housing washer
$d_1$	110 mm	Outer diameter shaft washer
R	90 mm	Radius spherical housing washer
A	41 mm	Distance of the center point
$T_1$	42 mm	Height with seat washer

## Temperature range

$T_{\min}$	-30 °C	Operating temperature min.
$T_{\max}$	150 °C	Operating temperature max.

## Calculation factors

A	0,28	Minimum load factor
---	------	---------------------

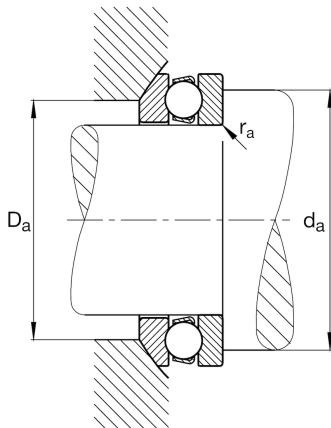
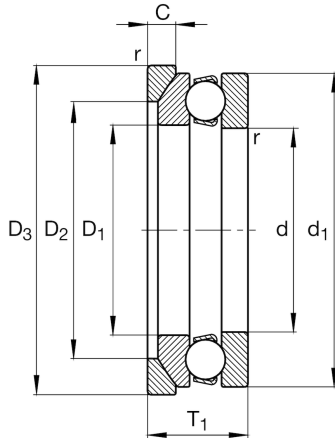
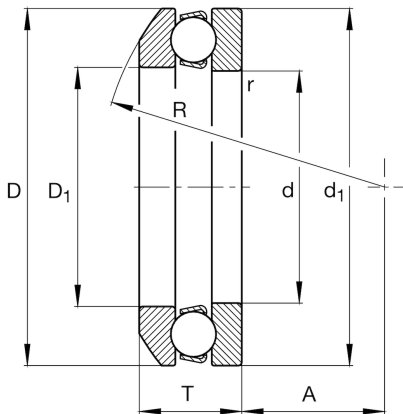



View product details on medias

19.04.2024, 17:03:07 CEST

SCHAEFFLER

### Additional information

U312

Seat washer

