**FAG****53234-MP**

Axial deep groove ball bearing

Axial deep groove ball bearing 532...-MP, single direction, with spherical housing washer, solid brass cage

Technical information

Main Dimensions & Performance Data

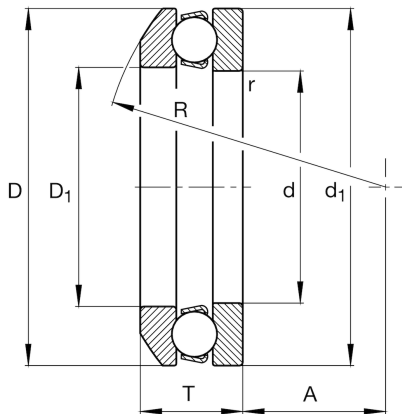

d	170 mm	Inner diameter shaft washer
D	240 mm	Outer diameter housing washer
T	58,7 mm	Height
C _a	285.000 N	Basic dynamic load rating, axial
C _{0a}	930.000 N	Basic static load rating, axial
C _{ua}	29.500 N	Fatigue load limit, axial
n _G	1.740 1/min	Limiting speed
n _{gr}	2.230 1/min	Reference speed
≈m	7,92 kg	Weight

Mounting dimensions

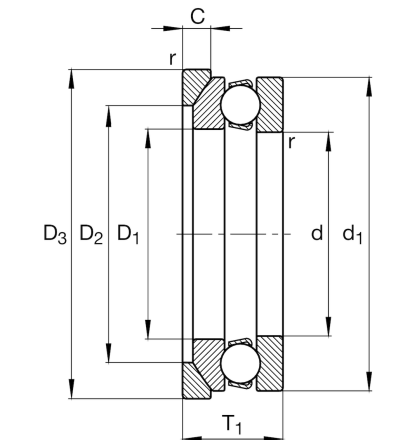

d _{a min}	212 mm	Minimum diameter shaft shoulder
D _{a max}	200 mm	Maximum diameter of housing shoulder
r _{a max}	1,5 mm	Maximum filled radius

Dimensions

r _{min}	1,5 mm	Minimum chamfer dimension
D ₁	173 mm	Inner diameter housing washer
d ₁	237 mm	Outer diameter shaft washer
R	180 mm	Radius spherical housing washer
A	91 mm	Distance of the center point
T ₁	65 mm	Height with seat washer

Temperature range

T _{min}	-30 °C	Operating temperature min.
T _{max}	150 °C	Operating temperature max.

Calculation factors

A	4,5	Minimum load factor
---	-----	---------------------

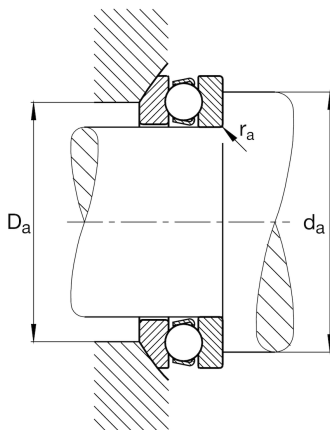



View product details on medias

12.04.2024, 17:19:44 CEST

SCHAEFFLER

Additional information

U234

Seat washer

