**FAG****53215**

Axial deep groove ball bearing

Axial deep groove ball bearing 532, single direction, with spherical housing washer, steel sheet metal cage

Technical information

Main Dimensions & Performance Data

d	75 mm	Inner diameter shaft washer
D	110 mm	Outer diameter housing washer
T	28,3 mm	Height
C_a	67.000 N	Basic dynamic load rating, axial
C_{0a}	169.000 N	Basic static load rating, axial
C_{ua}	7.700 N	Fatigue load limit, axial
n_G	3.950 1/min	Limiting speed
n_{gr}	4.300 1/min	Reference speed
$\approx m$	0,812 kg	Weight

Mounting dimensions

$d_{a \min}$	96 mm	Minimum diameter shaft shoulder
$D_{a \max}$	92 mm	Maximum diameter of housing shoulder
$r_{a \max}$	1 mm	Maximum filled radius

Dimensions

r_{\min}	1 mm	Minimum chamfer dimension
D_1	77 mm	Inner diameter housing washer
d_1	110 mm	Outer diameter shaft washer
R	90 mm	Radius spherical housing washer
A	49 mm	Distance of the center point
T_1	32 mm	Height with seat washer

Temperature range

T_{\min}	-30 °C	Operating temperature min.
T_{\max}	150 °C	Operating temperature max.

Calculation factors

A	0,18	Minimum load factor
---	------	---------------------

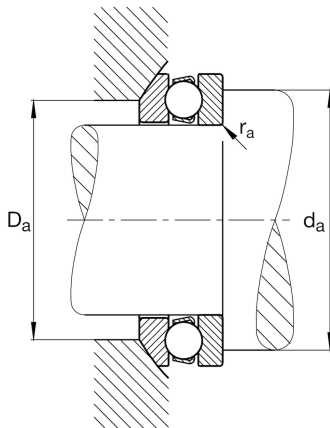
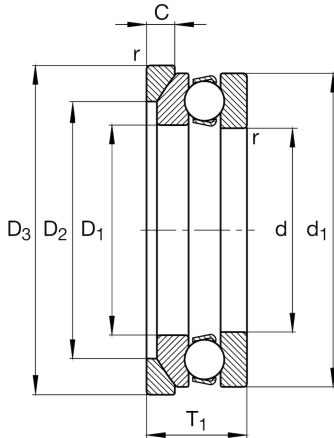
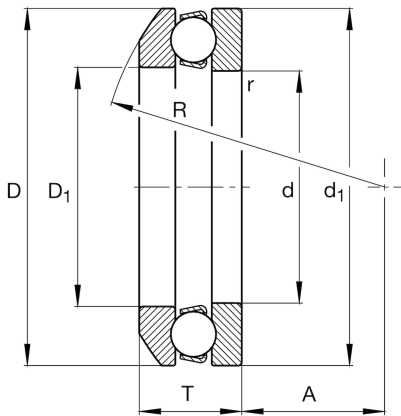



View product details on medias

12.04.2024, 16:36:58 CEST

SCHAEFFLER

Additional information

U215

Seat washer

