**FAG****53213**

Axial deep groove ball bearing

Axial deep groove ball bearing 532, single direction, with spherical housing washer, steel sheet metal cage

Technical information

Main Dimensions & Performance Data

d	65 mm	Inner diameter shaft washer
D	100 mm	Outer diameter housing washer
T	28,7 mm	Height
C _a	64.000 N	Basic dynamic load rating, axial
C _{0a}	149.000 N	Basic static load rating, axial
C _{ua}	6.800 N	Fatigue load limit, axial
n _G	4.100 1/min	Limiting speed
n _{gr}	4.900 1/min	Reference speed
≈m	0,727 kg	Weight

Mounting dimensions

d _{a min}	86 mm	Minimum diameter shaft shoulder
D _{a max}	82 mm	Maximum diameter of housing shoulder
r _{a max}	1 mm	Maximum filled radius

Dimensions

r _{min}	1 mm	Minimum chamfer dimension
D ₁	67 mm	Inner diameter housing washer
d ₁	100 mm	Outer diameter shaft washer
R	80 mm	Radius spherical housing washer
A	40 mm	Distance of the center point
T ₁	32 mm	Height with seat washer

Temperature range

T _{min}	-30 °C	Operating temperature min.
T _{max}	150 °C	Operating temperature max.

Calculation factors

A	0,14	Minimum load factor
---	------	---------------------

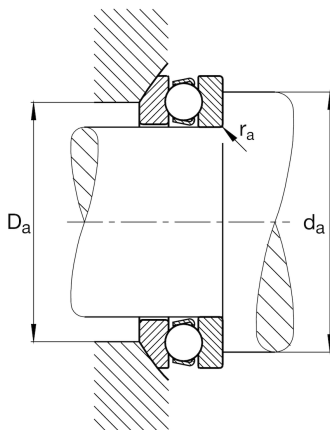
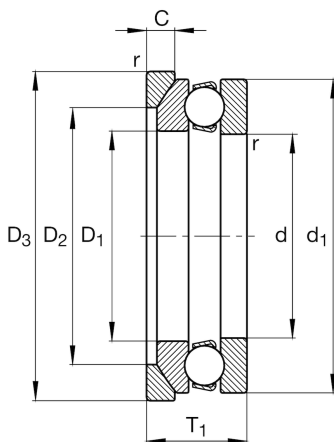
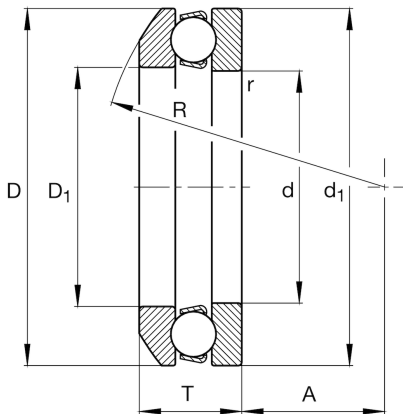



View product details on medias

12.04.2024, 16:26:37 CEST

SCHAEFFLER

Additional information

U213

Seat washer

