**FAG****53206**

Axial deep groove ball bearing

Axial deep groove ball bearing 532, single direction, with spherical housing washer, steel sheet metal cage

Technical information

Main Dimensions & Performance Data

d	30 mm	Inner diameter shaft washer
D	52 mm	Outer diameter housing washer
T	17,8 mm	Height
C_a	23.900 N	Basic dynamic load rating, axial
C_{0a}	46.000 N	Basic static load rating, axial
C_{ua}	2.100 N	Fatigue load limit, axial
n_G	7.300 1/min	Limiting speed
n_{gr}	8.600 1/min	Reference speed
$\approx m$	0,152 kg	Weight

Mounting dimensions

$d_{a \min}$	43 mm	Minimum diameter shaft shoulder
$D_{a \max}$	42 mm	Maximum diameter of housing shoulder
$r_{a \max}$	0,6 mm	Maximum filled radius

Dimensions

r_{\min}	0,6 mm	Minimum chamfer dimension
D_1	32 mm	Inner diameter housing washer
d_1	52 mm	Outer diameter shaft washer
R	45 mm	Radius spherical housing washer
A	22 mm	Distance of the center point
T_1	20 mm	Height with seat washer

Temperature range

T_{\min}	-30 °C	Operating temperature min.
T_{\max}	150 °C	Operating temperature max.

Calculation factors

A	0,014	Minimum load factor
---	-------	---------------------

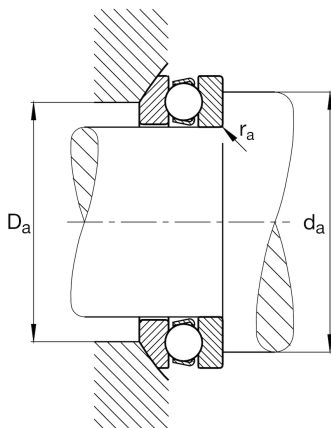
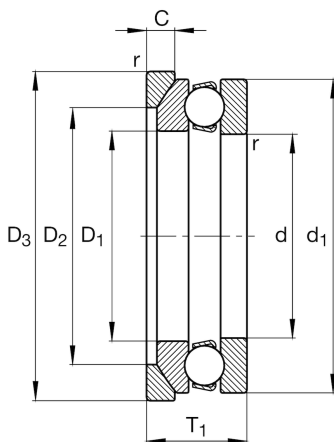
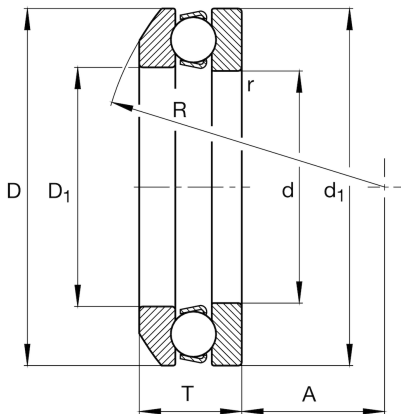



View product details on medias

12.04.2024, 15:06:33 CEST

SCHAEFFLER

Additional information

U206

Seat washer

