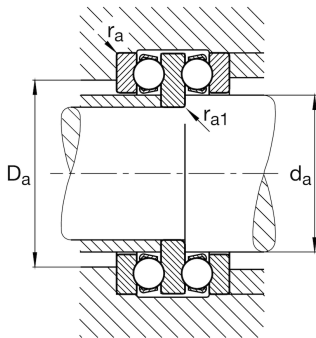
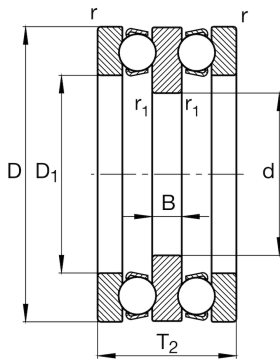

**FAG****52407**

Axial deep groove ball bearing

Axial deep groove ball bearing 524, double direction, steel sheet metal cage

Technical information

**Main Dimensions & Performance Data**

d	25 mm	Inner diameter shaft washer
D	80 mm	Outer diameter housing washer
T ₂	59 mm	Height
C _a	76.000 N	Basic dynamic load rating, axial
C _{0a}	126.000 N	Basic static load rating, axial
C _{ua}	5.700 N	Fatigue load limit, axial
n _G	3.600 1/min	Limiting speed
n _{gr}	8.000 1/min	Reference speed
≈m	1,44 kg	Weight

Mounting dimensions

d _{a max}	35 mm	Maximum diameter shaft shoulder
D _{a max}	53 mm	Maximum diameter of housing shoulder
r _{a max}	1 mm	Maximum filled radius
r _{a1 max}	0,6 mm	Maximum filled radius

Dimensions

D ₁	37 mm	Inner diameter housing washer
B	14 mm	Height shaft washer
r _{min}	1,1 mm	Minimum chamfer dimension
r _{1 min}	0,6 mm	Minimum chamfer dimension

Temperature range

T _{min}	-30 °C	Operating temperature min.
T _{max}	150 °C	Operating temperature max.

Calculation factors

A	0,11	Minimum load factor
---	------	---------------------