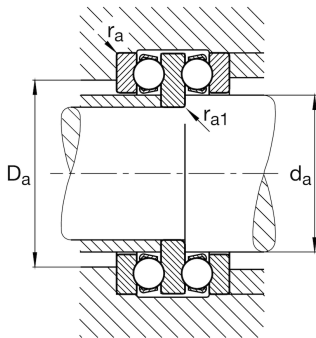
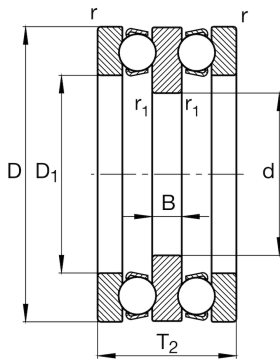
**FAG****52305**

Axial deep groove ball bearing

Axial deep groove ball bearing 523, double direction, steel sheet metal cage

## Technical information

**Main Dimensions & Performance Data**

d	20 mm	Inner diameter shaft washer
D	52 mm	Outer diameter housing washer
T <sub>2</sub>	34 mm	Height
C <sub>a</sub>	34.500 N	Basic dynamic load rating, axial
C <sub>0a</sub>	55.000 N	Basic static load rating, axial
C <sub>ua</sub>	2.500 N	Fatigue load limit, axial
n <sub>G</sub>	6.000 1/min	Limiting speed
n <sub>gr</sub>	9.700 1/min	Reference speed
≈m	290 g	Weight

**Mounting dimensions**

d <sub>a max</sub>	25 mm	Maximum diameter shaft shoulder
D <sub>a max</sub>	36 mm	Maximum diameter of housing shoulder
r <sub>a max</sub>	1 mm	Maximum filled radius
r <sub>a1 max</sub>	0,3 mm	Maximum filled radius

**Dimensions**

D <sub>1</sub>	27 mm	Inner diameter housing washer
B	8 mm	Height shaft washer
r <sub>min</sub>	1 mm	Minimum chamfer dimension
r <sub>1 min</sub>	0,3 mm	Minimum chamfer dimension

**Temperature range**

T <sub>min</sub>	-30 °C	Operating temperature min.
T <sub>max</sub>	150 °C	Operating temperature max.

**Calculation factors**

A	0,019	Minimum load factor
---	-------	---------------------