

**FAG****52222**

Axial deep groove ball bearing

Axial deep groove ball bearing 522, double direction, steel sheet metal cage

## Technical information

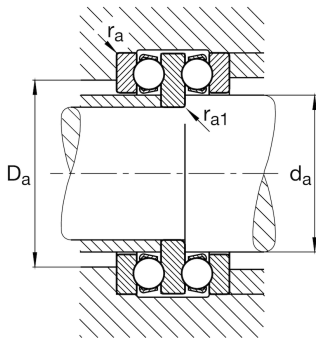
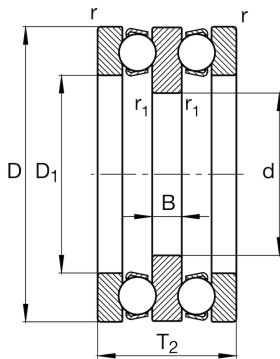

## Main Dimensions &amp; Performance Data

d	95 mm	Inner diameter shaft washer
D	160 mm	Outer diameter housing washer
T <sub>2</sub>	67 mm	Height
C <sub>a</sub>	126.000 N	Basic dynamic load rating, axial
C <sub>0a</sub>	365.000 N	Basic static load rating, axial
C <sub>ua</sub>	14.400 N	Fatigue load limit, axial
n <sub>G</sub>	2.650 1/min	Limiting speed
n <sub>gr</sub>	3.250 1/min	Reference speed
≈m	4,216 kg	Weight

## Mounting dimensions

d <sub>a max</sub>	110 mm	Maximum diameter shaft shoulder
D <sub>a max</sub>	130 mm	Maximum diameter of housing shoulder
r <sub>a max</sub>	1 mm	Maximum filled radius
r <sub>a1 max</sub>	1 mm	Maximum filled radius

## Dimensions

D <sub>1</sub>	113 mm	Inner diameter housing washer
B	15 mm	Height shaft washer
r <sub>min</sub>	1,1 mm	Minimum chamfer dimension
r <sub>1 min</sub>	1 mm	Minimum chamfer dimension

## Temperature range

T <sub>min</sub>	-30 °C	Operating temperature min.
T <sub>max</sub>	150 °C	Operating temperature max.

## Calculation factors

A	0,83	Minimum load factor
---	------	---------------------