

**FAG****52211**

Axial deep groove ball bearing

Axial deep groove ball bearing 522, double direction, steel sheet metal cage

Technical information

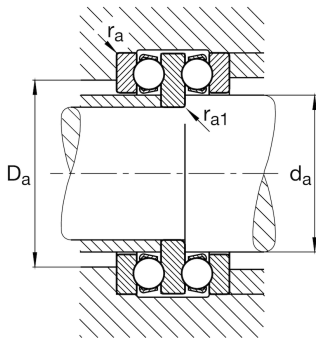
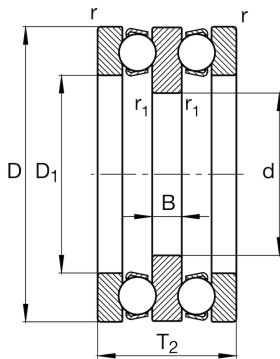

Main Dimensions & Performance Data

d	45 mm	Inner diameter shaft washer
D	90 mm	Outer diameter housing washer
T ₂	45 mm	Height
C _a	58.000 N	Basic dynamic load rating, axial
C _{0a}	133.000 N	Basic static load rating, axial
C _{ua}	6.000 N	Fatigue load limit, axial
n _G	4.350 1/min	Limiting speed
n _{gr}	5.600 1/min	Reference speed
≈m	1,033 kg	Weight

Mounting dimensions

d _{a max}	55 mm	Maximum diameter shaft shoulder
D _{a max}	69 mm	Maximum diameter of housing shoulder
r _{a max}	1 mm	Maximum filled radius
r _{a1 max}	0,6 mm	Maximum filled radius

Dimensions

D ₁	57 mm	Inner diameter housing washer
B	10 mm	Height shaft washer
r _{min}	1 mm	Minimum chamfer dimension
r _{1 min}	0,6 mm	Minimum chamfer dimension

Temperature range

T _{min}	-30 °C	Operating temperature min.
T _{max}	150 °C	Operating temperature max.

Calculation factors

A	0,11	Minimum load factor
---	------	---------------------