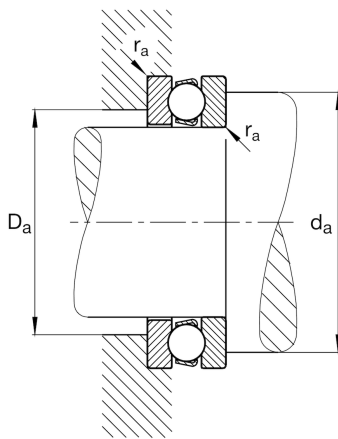
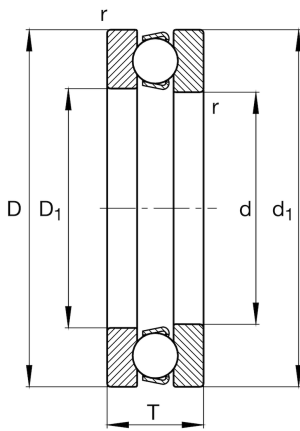

**FAG****51413-MP**

Axial deep groove ball bearing

Axial deep groove ball bearing 514...-MP, single direction, solid brass cage

Technical information

**Main Dimensions & Performance Data**

d	65 mm	Inner diameter shaft washer
D	140 mm	Outer diameter housing washer
T	56 mm	Height
C_a	217.000 N	Basic dynamic load rating, axial
C_{0a}	450.000 N	Basic static load rating, axial
C_{ua}	20.500 N	Fatigue load limit, axial
n_G	2.050 1/min	Limiting speed
n_{gr}	5.200 1/min	Reference speed
$\approx m$	4,47 kg	Weight

Mounting dimensions

$d_{a \min}$	110 mm	Minimum diameter shaft shoulder
$D_{a \max}$	95 mm	Maximum diameter of housing shoulder
$r_{a \max}$	2 mm	Maximum filled radius

Dimensions

r_{\min}	2 mm	Minimum chamfer dimension
D_1	68 mm	Inner diameter housing washer
d_1	140 mm	Outer diameter shaft washer

Temperature range

T_{\min}	-30 °C	Operating temperature min.
T_{\max}	150 °C	Operating temperature max.

Calculation factors

A	1,1	Minimum load factor
---	-----	---------------------