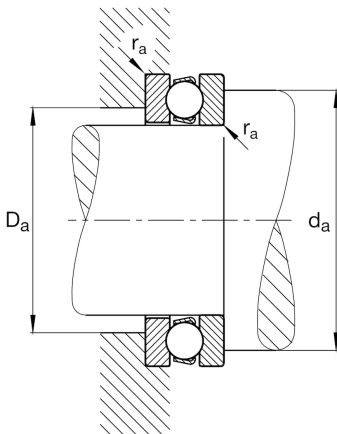

**FAG****51409**

Axial deep groove ball bearing

Axial deep groove ball bearing 514, single direction, steel sheet metal cage

Technical information

**Main Dimensions & Performance Data**

d	45 mm	Inner diameter shaft washer
D	100 mm	Outer diameter housing washer
T	39 mm	Height
C_a	123.000 N	Basic dynamic load rating, axial
C_{0a}	222.000 N	Basic static load rating, axial
C_{ua}	10.100 N	Fatigue load limit, axial
n_G	2.850 1/min	Limiting speed
n_{gr}	6.900 1/min	Reference speed
$\approx m$	1,424 kg	Weight

Mounting dimensions

$d_{a \min}$	78 mm	Minimum diameter shaft shoulder
$D_{a \max}$	67 mm	Maximum diameter of housing shoulder
$r_{a \max}$	1 mm	Maximum filled radius

Dimensions

r_{\min}	1,1 mm	Minimum chamfer dimension
D_1	47 mm	Inner diameter housing washer
d_1	100 mm	Outer diameter shaft washer

Temperature range

T_{\min}	-30 °C	Operating temperature min.
T_{\max}	150 °C	Operating temperature max.

Calculation factors

A	0,29	Minimum load factor
---	------	---------------------