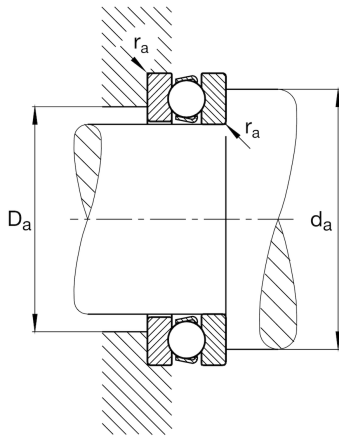
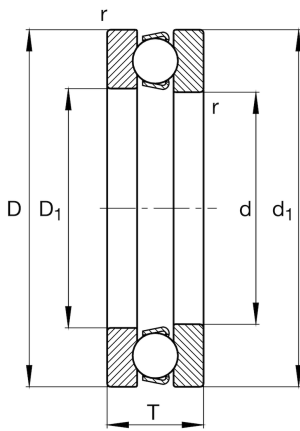

**FAG****51330-MP**

Axial deep groove ball bearing

Axial deep groove ball bearing 513...-MP,
single direction, solid brass cage

Technical information

**Main Dimensions & Performance Data**

d	150 mm	Inner diameter shaft washer
D	250 mm	Outer diameter housing washer
T	80 mm	Height
C_a	395.000 N	Basic dynamic load rating, axial
C_{0a}	1.330.000 N	Basic static load rating, axial
C_{ua}	43.000 N	Fatigue load limit, axial
n_G	1.340 1/min	Limiting speed
n_{gr}	2.480 1/min	Reference speed
$\approx m$	16,273 kg	Weight

Mounting dimensions

$d_{a \min}$	210 mm	Minimum diameter shaft shoulder
$D_{a \max}$	190 mm	Maximum diameter of housing shoulder
$r_{a \max}$	2,1 mm	Maximum filled radius

Dimensions

r_{\min}	2,1 mm	Minimum chamfer dimension
D_1	154 mm	Inner diameter housing washer
d_1	245 mm	Outer diameter shaft washer

Temperature range

T_{\min}	-30 °C	Operating temperature min.
T_{\max}	200 °C	Operating temperature max.

Calculation factors

A	9,3	Minimum load factor
---	-----	---------------------