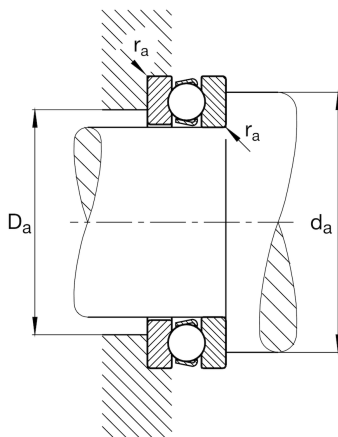
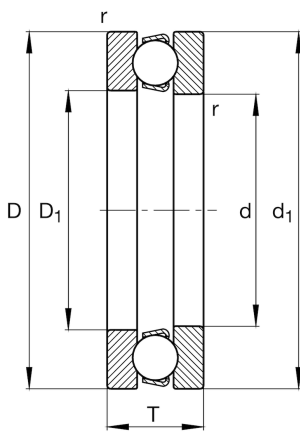

**FAG****51234-MP**

Axial deep groove ball bearing

Axial deep groove ball bearing 512...-MP, single direction, solid brass cage

Technical information

**Main Dimensions & Performance Data**

d	170 mm	Inner diameter shaft washer
D	240 mm	Outer diameter housing washer
T	55 mm	Height
C_a	285.000 N	Basic dynamic load rating, axial
C_{0a}	930.000 N	Basic static load rating, axial
C_{ua}	29.500 N	Fatigue load limit, axial
n_G	1.740 1/min	Limiting speed
n_{gr}	2.230 1/min	Reference speed
$\approx m$	8,132 kg	Weight

Mounting dimensions

$d_{a \min}$	212 mm	Minimum diameter shaft shoulder
$D_{a \max}$	198 mm	Maximum diameter of housing shoulder
$r_{a \max}$	1,5 mm	Maximum filled radius

Dimensions

r_{\min}	1,5 mm	Minimum chamfer dimension
D_1	173 mm	Inner diameter housing washer
d_1	237 mm	Outer diameter shaft washer

Temperature range

T_{\min}	-30 °C	Operating temperature min.
T_{\max}	150 °C	Operating temperature max.

Calculation factors

A	4,5	Minimum load factor
---	-----	---------------------