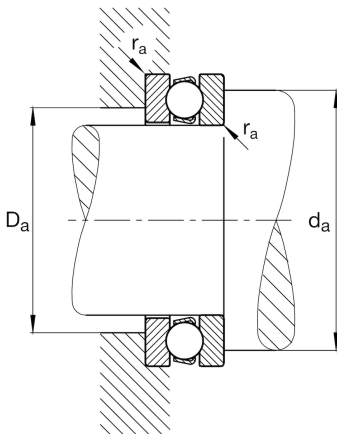

**FAG****51215**

Axial deep groove ball bearing

Axial deep groove ball bearing 512, single direction, steel sheet metal cage

Technical information

**Main Dimensions & Performance Data**

d	75 mm	Inner diameter shaft washer
D	110 mm	Outer diameter housing washer
T	27 mm	Height
C_a	67.000 N	Basic dynamic load rating, axial
C_{0a}	169.000 N	Basic static load rating, axial
C_{ua}	7.700 N	Fatigue load limit, axial
n_G	3.950 1/min	Limiting speed
n_{gr}	4.300 1/min	Reference speed
$\approx m$	0,795 kg	Weight

Mounting dimensions

$d_{a \min}$	96 mm	Minimum diameter shaft shoulder
$D_{a \max}$	89 mm	Maximum diameter of housing shoulder
$r_{a \max}$	1 mm	Maximum filled radius

Dimensions

r_{\min}	1 mm	Minimum chamfer dimension
D_1	77 mm	Inner diameter housing washer
d_1	110 mm	Outer diameter shaft washer

Temperature range

T_{\min}	-30 °C	Operating temperature min.
T_{\max}	150 °C	Operating temperature max.

Calculation factors

A	0,18	Minimum load factor
---	------	---------------------