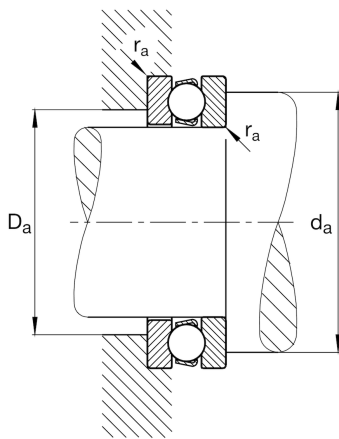
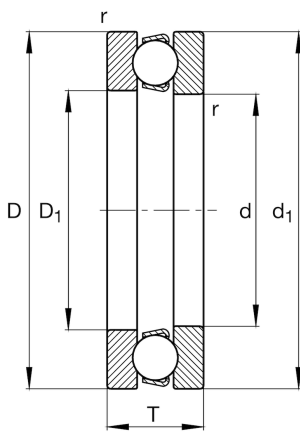

**FAG****51152-MP**

Axial deep groove ball bearing

Axial deep groove ball bearing 511...-MP,
single direction, solid brass cage

Technical information

**Main Dimensions & Performance Data**

d	260 mm	Inner diameter shaft washer
D	320 mm	Outer diameter housing washer
T	45 mm	Height
C_a	245.000 N	Basic dynamic load rating, axial
C_{0a}	1.070.000 N	Basic static load rating, axial
C_{ua}	29.000 N	Fatigue load limit, axial
n_G	1.560 1/min	Limiting speed
n_{gr}	1.390 1/min	Reference speed
$\approx m$	8,03 kg	Weight

Mounting dimensions

$d_{a \min}$	296 mm	Minimum diameter shaft shoulder
$D_{a \max}$	284 mm	Maximum diameter of housing shoulder
$r_{a \max}$	1,5 mm	Maximum filled radius

Dimensions

r_{\min}	1,5 mm	Minimum chamfer dimension
D_1	263 mm	Inner diameter housing washer
d_1	317 mm	Outer diameter shaft washer

Temperature range

T_{\min}	-30 °C	Operating temperature min.
T_{\max}	200 °C	Operating temperature max.

Calculation factors

A	6,1	Minimum load factor
---	-----	---------------------