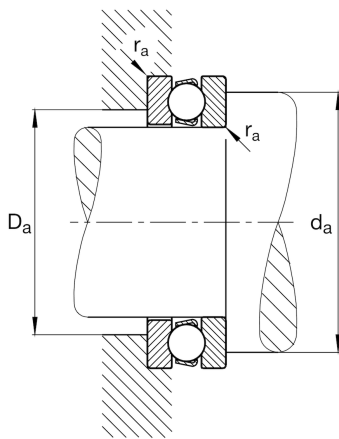
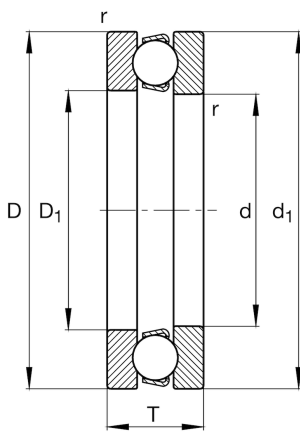

**FAG****51138-MP**

Axial deep groove ball bearing

Axial deep groove ball bearing 511...-MP,  
single direction, solid brass cage

## Technical information

**Main Dimensions & Performance Data**

d	190 mm	Inner diameter shaft washer
D	240 mm	Outer diameter housing washer
T	37 mm	Height
$C_a$	161.000 N	Basic dynamic load rating, axial
$C_{0a}$	650.000 N	Basic static load rating, axial
$C_{ua}$	20.200 N	Fatigue load limit, axial
$n_G$	2.040 1/min	Limiting speed
$n_{gr}$	1.850 1/min	Reference speed
$\approx m$	4,06 kg	Weight

**Mounting dimensions**

$d_{a \min}$	220 mm	Minimum diameter shaft shoulder
$D_{a \max}$	210 mm	Maximum diameter of housing shoulder
$r_{a \max}$	1 mm	Maximum filled radius

**Dimensions**

$r_{\min}$	1,1 mm	Minimum chamfer dimension
$D_1$	193 mm	Inner diameter housing washer
$d_1$	237 mm	Outer diameter shaft washer

**Temperature range**

$T_{\min}$	-30 °C	Operating temperature min.
$T_{\max}$	150 °C	Operating temperature max.

**Calculation factors**

A	2,3	Minimum load factor
---	-----	---------------------