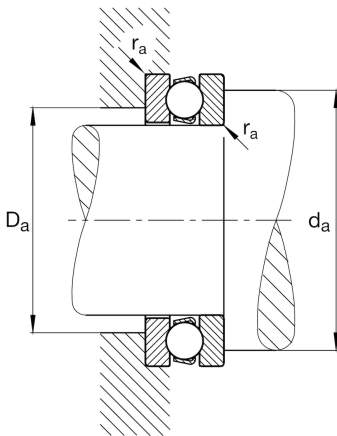
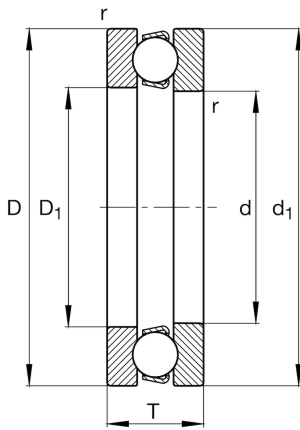

**FAG****51105**

Axial deep groove ball bearing

Axial deep groove ball bearing 511, single direction, steel sheet metal cage

## Technical information

**Main Dimensions & Performance Data**

d	25 mm	Inner diameter shaft washer
D	42 mm	Outer diameter housing washer
T	11 mm	Height
$C_a$	18.100 N	Basic dynamic load rating, axial
$C_{0a}$	35.500 N	Basic static load rating, axial
$C_{ua}$	1.620 N	Fatigue load limit, axial
$n_G$	9.700 1/min	Limiting speed
$n_{gr}$	9.500 1/min	Reference speed
$\approx m$	55 g	Weight

**Mounting dimensions**

$d_{a \min}$	35 mm	Minimum diameter shaft shoulder
$D_{a \max}$	32 mm	Maximum diameter of housing shoulder
$r_{a \max}$	0,6 mm	Maximum filled radius

**Dimensions**

$r_{\min}$	0,6 mm	Minimum chamfer dimension
$D_1$	26 mm	Inner diameter housing washer
$d_1$	42 mm	Outer diameter shaft washer

**Temperature range**

$T_{\min}$	-30 °C	Operating temperature min.
$T_{\max}$	150 °C	Operating temperature max.

**Calculation factors**

A	0,006	Minimum load factor
---	-------	---------------------