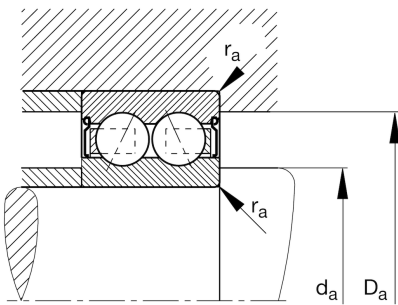
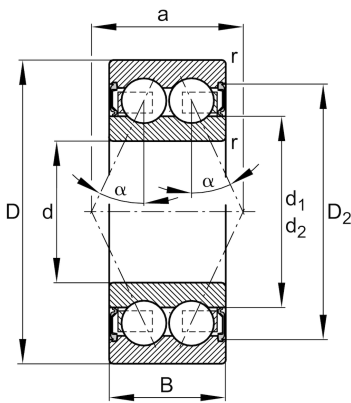

**3811-2RS**

Angular contact ball bearing

Angular contact ball bearing 38..-B-2RS-TVH, double row, seals, plastic cage

Technical information

**Main Dimensions & Performance Data**

d	55 mm	Bore diameter
D	72 mm	Outside diameter
B	13 mm	Width
C_r	10.700 N	Basic dynamic load rating, radial
C_{0r}	13.100 N	Basic static load rating, radial
C_{ur}	760 N	Fatigue load limit, radial
n_G	4.300 1/min	Limiting speed
$\approx m$	0,134 kg	Weight

Mounting dimensions

$d_{a \min}$	57 mm	Minimum diameter shaft shoulder
$D_{a \max}$	70 mm	Maximum diameter of housing shoulder
$r_{a \max}$	0,3 mm	Maximum fillet radius

Dimensions

r_{\min}	0,3 mm	Minimum chamfer dimension
D_1	67,93 mm	Shoulder diameter outer ring
D_2	69,02 mm	Caliber diameter outer ring
d_1	63,1 mm	Shoulder diameter inner ring
d_2	61,33 mm	Caliber diameter inner ring
a	34,9 mm	Distance between the apexes of the pressure cones
α	25 °	Contact angle

Temperature range

T_{\min}	-20 °C	Operating temperature min.
T_{\max}	100 °C	Operating temperature max.