



3005-2RS

Angular contact ball bearing

Schaeffler ID:
0009589480000

Angular contact ball bearing 30..-B-2RS-TVH, double row, seals, plastic cage

Technical information

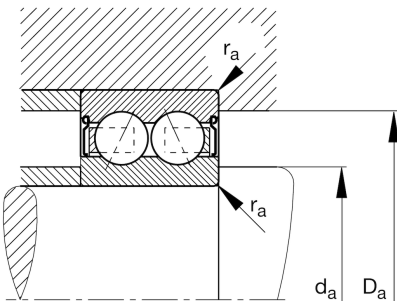
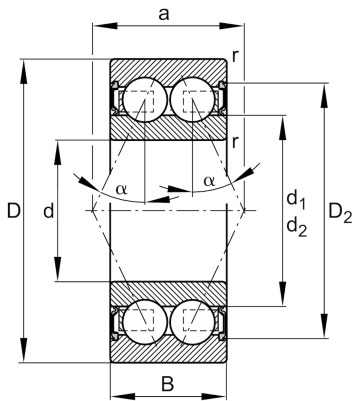

Main Dimensions & Performance Data

d	25 mm	Bore diameter
D	47 mm	Outside diameter
B	16 mm	Width
C_r	15.200 N	Basic dynamic load rating, radial
C_{0r}	10.900 N	Basic static load rating, radial
C_{ur}	570 N	Fatigue load limit, radial
n_G	8.800 1/min	Limiting speed
$\approx m$	0,107 kg	Weight

Mounting dimensions

$d_{a \min}$	28,2 mm	Minimum diameter shaft shoulder
$D_{a \max}$	43,8 mm	Maximum diameter of housing shoulder
$r_{a \max}$	0,6 mm	Maximum fillet radius

Dimensions

r_{\min}	0,6 mm	Minimum chamfer dimension
D_2	41,8 mm	Caliber diameter outer ring
d_2	30,3 mm	Caliber diameter inner ring
a	23,4 mm	Distance between the apexes of the pressure cones
α	25 °	Contact angle

Temperature range

T_{\min}	-20 °C	Operating temperature min.
T_{\max}	100 °C	Operating temperature max.