

FAG

234411-M-SP

Axial angular contact ball bearing

Schaeffler ID:
0190388010000Axial angular contact ball bearings 2344,
double direction, separable, restricted
tolerances

Technical information

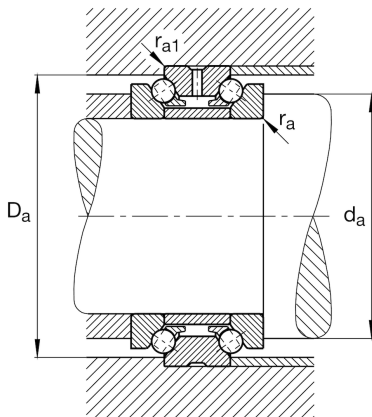
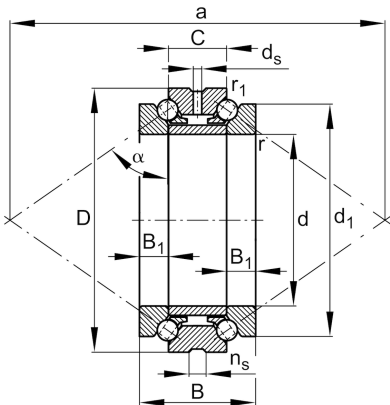
**Main Dimensions & Performance Data**

d	55 mm	Bore diameter
D	90 mm	Outside diameter
B	44 mm	Width
C	22 mm	Width, outer ring
C _a	37.500 N	Basic dynamic load rating, axial
C _{0a}	102.000 N	Basic static load rating, axial
C _{ua}	9.500 N	Fatigue load limit, axial
n _{G Grease}	6.300 1/min	Limiting speed for grease lubrication
n _{G Oil}	8.500 1/min	Limiting speed for oil lubrication
≈m	0,946 kg	Weight

Mounting dimensions

d _a	69 mm	Diameter shaft shoulder
d _a	h12	Diameter shaft shoulder clearance
D _a	84,5 mm	Shoulder diameter outer ring
D _a	H12	Shoulder diameter outer ring clearance
r _{a max}	1,1 mm	Maximum recess radius
r _{a1 max}	0,3 mm	Maximum recess radius
α	60 °	Contact angle
a	150 mm	Distance between the apexes of the pressure cones

Dimensions

d ₁	78 mm	Rip diameter shaft washer
B ₁	11 mm	Height wave disc
r _{min}	1,1 mm	Minimum chamfer dimension
r _{1 min}	0,3 mm	Minimum chamfer dimension
d _s	3,2 mm	Diameter lubrication hole
n _s	6,5 mm	Width of lubricating groove

Temperature range

T_{\min}	-30 °C	Operating temperature min.
T_{\max}	150 °C	Operating temperature max.

Additional information

c_a	458 N/ μm	Axial rigidity
K_{aE}	743 N	Lift-off force
F_v	260 N	Preload force