

PUSH-IN FITTINGS FOR USE IN THE FOOD INDUSTRY

SERIES F-E PLUS FITTINGS

With the fittings in the F-E Plus series, you can extend all the advantages of the Metal Work push-in fittings to the food industry as well.

As is known, a Metal Work push-in fitting can be reused thousands of times without affecting the pneumatic and mechanical tightness. The refined profile of the clamping spring retains the pipe without cutting or deforming it. The characteristic element of the F-E Plus fittings is the use of materials and lubricants that are chosen for the specific field of application.

All brass component parts undergo a clean-lead process, which consists of removing lead from the surface layer of the fitting; the gaskets are made of special FDA-approved Viton®.

Engineering plastic materials are suitable for use at high temperatures and in contact with water.

The fitting can be used up to 150°C depending on the choice of materials, which makes it ideal for use in applications at high temperatures.

The threads are cylindrical and under-head O-rings provide a pneumatic seal. This avoids the need for sealants (e.g. Teflon®), which could release solid fragments during screwing and unscrewing that would contaminate the environment or the fluid. Our fittings can be screwed and unscrewed any number of times and still remain clean and pneumatically sealed.

In addition to the standard range available, many other configurations can be created on specific request.



TECHNICAL DATA

Threaded port		Metric: M5
Diameter		G (BSP)*: 1/8 - 1/4 - 3/8 - 1/2 Ø 4 - Ø 6 - Ø 8 - Ø 10
Temperature range	°C	- 20 to + 150
	°F	- 4 to 302
Pressure range	bar	- 0.99 to +16
	MPa	- 0.099 to +1.6
Recommended pipe		Rilsan PA 11 - Nylon 6 - Polyamide 12 - Polypropylene PTFE for temperatures over 60°C
Fluid		Vacuum - Compressed air

* Metric cylindrical threads according to ISO 262

Cylindrical threads according to ISO 228-1, identified with a letter G. They also correspond to BSP or more precisely to BSPP designation (P stands for Parallel).

Conical threads according to ISO 7-1, identified by a letter R. They also correspond to BSP or more precisely to BSPT designation (T stands for Tapered).

COMPONENTS

- ① Release bushing: PPSU
- ② Locking bushing: PPSU
- ③ Body: unleaded brass treated with environmentally-friendly intermetallic alloy
- ④ Clamping spring: stainless steel
- ⑤ Spring supporting ring: PPSU
- ⑥ Seal: FDA-approved Viton®

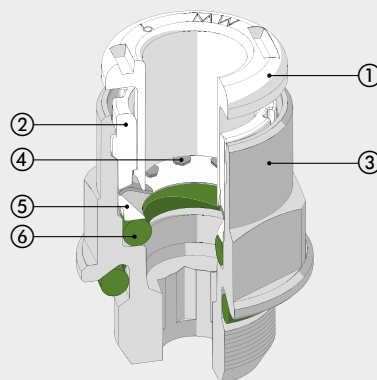

ADVANTAGES / CERTIFICATIONS

ADVANTAGES

Under-head O-ring

Can be screwed and unscrewed any number of times; no fragments of Teflon® or sealant will contaminate the fluid.

Corrosion resistance

The intermetallic alloy deposited on the surface and Viton® are compatible with numerous substances.

CONFORMITY DECLARATIONS

- Regulation 1935/04 EU.*
- Regulation 2023/06 EU.

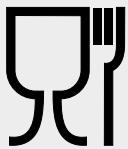

* Release tests performed at 50°C for 30 minutes.

INSTALLING THE PIPE

Compressed air pipes must be used in compliance with some basic criteria in order to ensure long life and proper operation of the fitting:

- check that the conditions for the installation and use (e.g. temperature and fluid used) comply with the characteristics stated by the pipe manufacturer;
- check the pipe size; oversized pipes could not fit properly, undersized ones could not ensure pipe retention and air tightness.

The cut should be as accurate as possible at a right angle with the pipe axis.

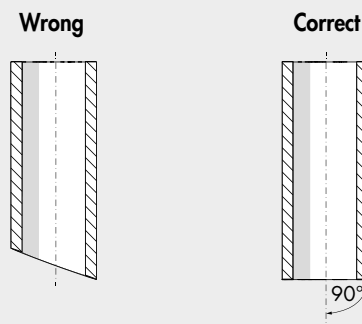

- the bending radius of the pipe installed must be as wide as possible. The fittings have been designed to ensure axial seal of the pipe; excessive curvature could considerably shorten the life of the pipe.
- the pipe must not be subjected to excessive axial stress and it must be of the right length for snugly fitting (not too long or too short).
- correct insertion of the pipe into the fitting is essential for air tightness and pipe retention. Make sure that the pipe is pushed right into the seat.
- check that the pipe does not encounter any obstacles or blockages along its way, which could cause tensile stress of the pipe in the fitting.

STRAIGHT, CYLINDRICAL, MALE R1 F-E PLUS

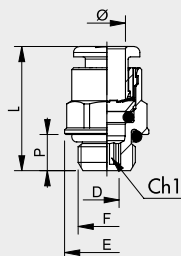

Code	Ref.	Ø	F	Ch	Ch1	P	L	D	E
2FP0101	R1 F-E-P	4	M5	Ø9	2.5	4	20.3	2.6	9
2FP0102	R1 F-E-P	4	1/8	10	3	6	18	3.1	14
2FP0103	R1 F-E-P	4	1/4	10	3	8	19.8	3.1	18
2FP0100	R1 F-E-P	6	M5	Ø11	2.5	4	21.9	2.6	11
2FP0107	R1 F-E-P	6	1/8	12	4	6	21.6	4.1	14
2FP0108	R1 F-E-P	6	1/4	12	4	8	20.3	4.1	18
2FP0109	R1 F-E-P	8	1/8	13	5	6	25.4	5.2	14
2FP0110	R1 F-E-P	8	1/4	14	6	8	24.4	6.2	18
2FP0111	R1 F-E-P	8	3/8	14	6	9	22.8	6.2	22
2FP0112	R1 F-E-P	10	1/4	16	7	8	29.2	7.2	18
2FP0113	R1 F-E-P	10	3/8	16	8	9	26.5	8.2	22
2FP0122	R1 F-E-P	10	1/2	16	8	11	29.8	8.2	26

STRAIGHT, CONICAL, MALE R1C F-E PLUS

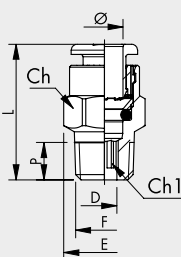

Code	Ref.	Ø	F	Ch	Ch1	P	L	D	E
2FP1C02	R1/C F-E-P	4	1/8	10	3	6.2	18.5	3.1	11.3
2FP1C07	R1/C F-E-P	6	1/8	12	4	6.2	22.5	4.1	13.5
2FP1C08	R1/C F-E-P	6	1/4	12	4	8.5	22.3	4.1	13.2
2FP1C09	R1/C F-E-P	8	1/8	13	6	6.2	26	6.2	14.3
2FP1C10	R1/C F-E-P	8	1/4	14	6	8.5	25.5	6.2	15.8
2FP1C11	R1/C F-E-P	8	3/8	14	6	9	24.9	6.2	16.6
2FP1C13	R1/C F-E-P	10	1/4	16	7	8.5	28.9	7.2	17.7
2FP1C14	R1/C F-E-P	10	3/8	16	8	9	26	8.2	17.7

STRAIGHT, FEMALE R2 F-E PLUS

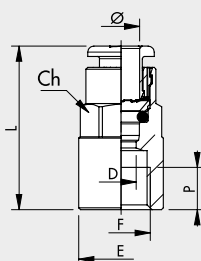

Code	Ref.	Ø	F	Ch	P	L	D	E
2FP0201	R2 F-E-P	4	1/8	10	7	26.2	3	14
2FP0205	R2 F-E-P	6	1/8	12	7	27.1	5	14
2FP0206	R2 F-E-P	6	1/4	12	8	29.3	5	17
2FP0207	R2 F-E-P	8	1/8	13	7	28.1	7	14
2FP0208	R2 F-E-P	8	1/4	14	8	30	7	17
2FP0211	R2 F-E-P	10	1/4	16	8	31.8	8	17.7

STRAIGHT, INTERMEDIATE R3 F-E PLUS



Code	Ref.	Ø1	Ø2	F	L	D
2FP0301	R3 F-E-P	4	4	M11x1	30.6	2.5
2FP0303	R3 F-E-P	6	6	M13x1	33	4.5
2FP0304	R3 F-E-P	8	8	M15x1	35.7	6.5
2FP0305	R3 F-E-P	10	10	M17x1	39.2	8

ELBOW, INTERMEDIATE R4 F-E PLUS

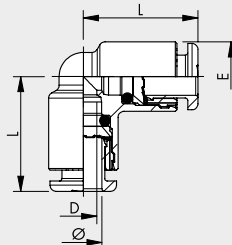

Code	Ref.	Ø	L	D	E
2FP0401	R4 F-E-P	4	16.7	2.5	9.5
2FP0403	R4 F-E-P	6	19	4.5	11.5
2FP0404	R4 F-E-P	8	21.3	6.5	13.5
2FP0405	R4 F-E-P	10	23.3	8	16

TEE, INTERMEDIATE R5 F-E PLUS

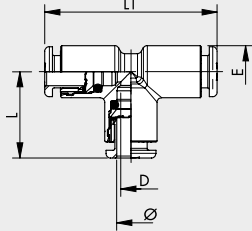

Code	Ref.	Ø	L	L1	D	E
2FP0501	R5 F-E-P	4	16.7	33.4	2.5	9.5
2FP0503	R5 F-E-P	6	19	38	4.5	11.5
2FP0504	R5 F-E-P	8	21.3	42.6	6.5	13.5
2FP0505	R5 F-E-P	10	23.3	46.6	8	16

THREADED ADAPTER R6 F-E

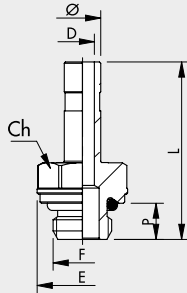

Code	Ref.	Ø	F	Ch	P	L	D	E
2F06001	R6 F-E	4	M5	8	4	25.2	2.5	9
2F06002	R6 F-E	4	1/8	13	6	28.9	2.5	15
2F06003	R6 F-E	4	1/4	14	8	32.4	2.2	18
2F06000	R6 F-E	6	M5	9	4	25.7	2.7	10
2F06007	R6 F-E	6	1/8	13	6	29.4	4	15
2F06008	R6 F-E	6	1/4	14	8	32.9	4	18
2F06009	R6 F-E	8	1/8	13	6	30.6	5.5	15
2F06010	R6 F-E	8	1/4	14	8	34	6	18
2F06011	R6 F-E	8	3/8	17	9	35.4	6	22
2F06012	R6 F-E	10	1/4	14	8	38.2	7.8	18
2F06013	R6 F-E	10	3/8	17	9	38.7	8	22

STRAIGHT, INTERMEDIATE, BULKHEAD UNIONS R10 F-E PLUS

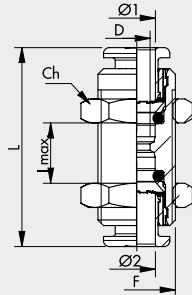

Code	Ref.	Ø1	Ø2	F	Ch	L	D	L _{MAX}
2FP1101	R10 F-E-P	4	4	M11x1	13	30.6	2.5	11
2FP1103	R10 F-E-P	6	6	M13x1	16	33	4.5	12
2FP1104	R10 F-E-P	8	8	M15x1	17	35.7	6.5	13.5
2FP1105	R10 F-E-P	10	10	M17x1	20	39.2	8	17

ROTARY ELBOW, MALE, CYLINDRICAL R31 F-E PLUS

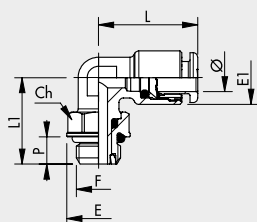

Code	Ref.	Ø	F	Ch	E	E1	L	L1	P
2FP3101	R31 F-E-P	4	M5	9	9.9	9.5	18.6	15.3	4
2FP3102	R31 F-E-P	4	1/8	12	14	9.5	18.6	19.1	6
2FP3103	R31 F-E-P	4	1/4	14	18	9.5	18.6	21.1	8
2FP3107	R31 F-E-P	6	M5	9	9.9	11.8	21.9	15.3	4
2FP3108	R31 F-E-P	6	1/8	12	14	11.8	21.9	19.1	6
2FP3109	R31 F-E-P	6	1/4	14	18	11.8	21.9	21.1	8
2FP3110	R31 F-E-P	8	1/8	12	14	13.5	25.4	19.1	6
2FP3111	R31 F-E-P	8	1/4	14	18	13.5	25.4	21.1	8
2FP3112	R31 F-E-P	8	3/8	17	22	13.8	25.4	27.1	9
2FP3113	R31 F-E-P	10	1/4	14	18	16	27.2	24.8	8
2FP3114	R31 F-E-P	10	3/8	17	22	16	27.2	27.1	9
2FP3115	R31 F-E-P	10	1/2	22	26	16	27.2	30.7	11

ROTARY ELBOW, MALE, CONICAL R31C F-E PLUS

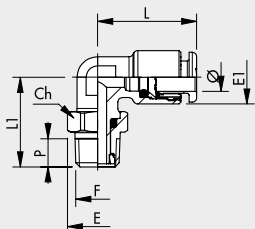

Code	Ref.	Ø	F	Ch	E	E1	L	L1	P
2FP2C02	R31/C F-E-P	4	1/8	12	13.3	9.5	18.6	19.8	6.2
2FP2C03	R31/C F-E-P	4	1/4	14	15.4	9.5	18.6	22.6	8.5
2FP2C08	R31/C F-E-P	6	1/8	12	13.3	11.8	21.9	19.8	6.2
2FP2C09	R31/C F-E-P	6	1/4	14	15.4	11.8	21.9	22.6	8.5
2FP2C10	R31/C F-E-P	8	1/8	12	13.3	13.5	25.4	19.8	6.2
2FP2C11	R31/C F-E-P	8	1/4	14	15.4	13.5	25.4	23.6	8.5
2FP2C12	R31/C F-E-P	8	3/8	17	19.2	13.8	23.6	27.1	9
2FP2C13	R31/C F-E-P	10	1/4	14	15.4	16	27.2	26.3	8.5
2FP2C14	R31/C F-E-P	10	3/8	17	19.2	16	27.2	27.1	9

CENTRAL TEE, MALE, CYLINDRICAL, ROTARY R32 F-E PLUS

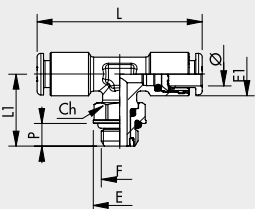

Code	Ref.	Ø	F	Ch	E	E1	L	L1	P
2FP3202	R32 F-E-P	4	1/8	12	14	9.5	37.2	19.1	6
2FP3208	R32 F-E-P	6	1/8	12	14	11.8	43.8	19.1	6
2FP3209	R32 F-E-P	6	1/4	14	18	11.8	43.8	21.1	8
2FP3210	R32 F-E-P	8	1/8	12	14	13.5	50.8	19.1	6
2FP3211	R32 F-E-P	8	1/4	14	18	13.5	50.8	21.1	8
2FP3212	R32 F-E-P	8	3/8	17	22	13.8	47.2	27.1	9
2FP3213	R32 F-E-P	10	1/4	14	18	16	44.4	21.8	8
2FP3214	R32 F-E-P	10	3/8	17	22	16	44.4	27.1	9

LATERAL TEE, MALE, CYLINDRICAL, ROTARY R38 F-E PLUS

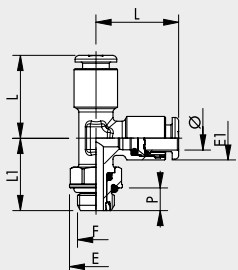

Code	Ref.	Ø	F	Ch	E	E1	L	L1	P
2FP3802	R38 F-E-P	4	1/8	12	14	9.5	18.6	19.1	6
2FP3808	R38 F-E-P	6	1/8	12	14	11.5	21.9	19.1	6
2FP3809	R38 F-E-P	6	1/4	14	18	11.5	21.9	21.1	8
2FP3810	R38 F-E-P	8	1/8	12	14	13.5	25.4	19.1	6
2FP3811	R38 F-E-P	8	1/4	14	18	13.5	25.4	22.4	8
2FP3813	R38 F-E-P	10	1/4	14	18	16	27.2	21.8	8
2FP3814	R38 F-E-P	10	3/8	17	22	16	27.2	27.1	9

ELBOW, MALE, CONICAL R39C F-E PLUS

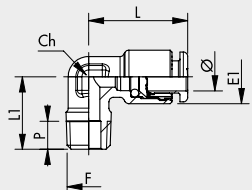

Code	Ref.	Ø	F	Ch	E1	L	L1	P
2FP4C02	R39/C F-E-P	4	1/8	10	9.5	18.6	16	6.2
2FP4C08	R39/C F-E-P	6	1/8	10	11.8	21.9	16	6.2
2FP4C09	R39/C F-E-P	6	1/4	10	11.8	21.9	18.5	8.5
2FP4C10	R39/C F-E-P	8	1/8	10	13.5	24.5	16	6.2
2FP4C11	R39/C F-E-P	8	1/4	10	13.5	25.4	18.5	8.5
2FP4C12	R39/C F-E-P	8	3/8	14	13.8	25.4	22.5	9
2FP4C13	R39/C F-E-P	10	1/4	14	16	27.2	22	8.5

SERIES F-NSF PLUS FITTINGS

The fittings in the F-NSF Plus series encompass all the advantages of Metal Work push-in fittings in one NSF-certified product.

As is known, a Metal Work push-in fitting can be reused thousands of times without affecting the perfect pneumatic and mechanical tightness.

The refined profile of the clamping spring retains the pipe without cutting or deforming it.

The fittings in this series also feature a double internal O-ring seal for enhanced safe tightness, especially when using water or other fluids.

The materials and lubricants used in these fittings are suitable for use in the food industry and for operation in contact with cold and hot drinking water.

The fittings in the F-NSF Plus series are made of brass with a low lead content ($\leq 0.1\%$) that is subject to a further process that extracts the lead from the surface layer of the product; the gaskets are made of special FDA-approved Viton®.

Engineering plastics are ideal for use at a high temperature and in contact with water.

The fitting can be used up to 150°C depending on the choice of materials, which makes it ideal for use in applications at high temperatures.

The threads are cylindrical and under-head O-rings provide a pneumatic seal. This avoids the need for sealants (e.g. Teflon®), which could release solid fragments during screwing and unscrewing that would contaminate the environment or the fluid. Our fittings can be screwed and unscrewed any number of times and still remain clean and pneumatically sealed.

In addition to the standard range available, many other configurations can be created on specific request.



TECHNICAL DATA		
Threaded port		G (BSP)*: 1/8 - 1/4
Diameter		Ø 4 - Ø 6
Temperature range	°C	- 20 to + 150
	°F	- 4 to 302
Pressure range	bar	- 0.99 to +16
	MPa	- 0.099 to +1.6
Recommended pipe		PTFE
Fluid		Vacuum - Compressed air

* Cylindrical threads according to ISO 228-1, identified with a letter G. They also correspond to BSP or more precisely to BSPP designation (P stands for Parallel).

COMPONENTS

- ① Release bushing: PPSU
- ② Locking bushing: PPSU
- ③ Body: low-lead brass ($\leq 0.1\%$)
- ④ Clamping spring: stainless steel
- ⑤ Spring supporting ring: PPSU
- ⑥ Seal: FDA-approved Viton®

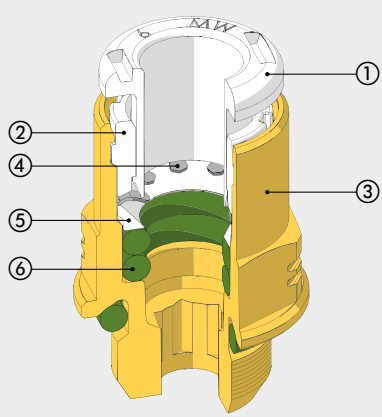

ADVANTAGES / CERTIFICATIONS

ADVANTAGES

Under-head O-ring

Can be screwed and unscrewed any number of times; no fragments of Teflon® or sealant will contaminate the fluid.

CONFORMITY DECLARATIONS

- NSF/ANSI 372 standard: drinking water system components - Lead Content.
- DM 174
- Regulation 1935/04 EU.*
- Regulation 2023/06 EU.



* Release tests performed at 50°C for 30 minutes.

CERTIFIED

- NSF/ANSI 169 standard: products in contact with food.



INSTALLING THE PIPE

Compressed air pipes must be used in compliance with some basic criteria in order to ensure long life and proper operation of the fitting:

- check that the conditions for the installation and use (e.g. temperature and fluid used) comply with the characteristics stated by the pipe manufacturer;
- check the pipe size; oversized pipes could not fit properly, undersized ones could not ensure pipe retention and air tightness.

The cut should be as accurate as possible at a right angle with the pipe axis.

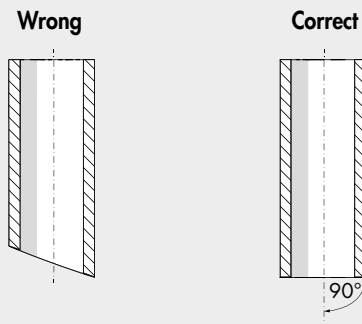

- the bending radius of the pipe installed must be as wide as possible. The fittings have been designed to ensure axial seal of the pipe; excessive curvature could considerably shorten the life of the pipe.
- the pipe must not be subjected to excessive axial stress and it must be of the right length for snugly fitting (not too long or too short).
- correct insertion of the pipe into the fitting is essential for air tightness and pipe retention. Make sure that the pipe is pushed right into the seat.
- check that the pipe does not encounter any obstacles or blockages along its way, which could cause tensile stress of the pipe in the fitting.

STRAIGHT, CYLINDRICAL, MALE R1 F-NSF PLUS

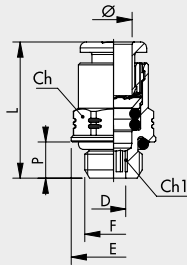

Code	Ref.	Ø	F	Ch	Ch1	P	L	D	E
2FP0152	R1 F-NSF P	4	1/8	10	3	6	20	3.1	14
2FP0153	R1 F-NSF P	4	1/4	10	3	8	21.8	3.1	18
2FP0157	R1 F-NSF P	6	1/8	12	4	6	23.6	4.1	14
2FP0158	R1 F-NSF P	6	1/4	12	4	8	22.6	4.1	18

ROTARY ELBOW, MALE, CYLINDRICAL R31 F-NSF PLUS

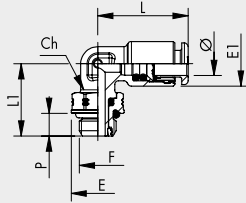

Code	Ref.	Ø	F	Ch	E	E1	L	L1	P
2FP3152	R31 F-NSF P	4	1/8	12	14	9.5	20.6	19.1	6
2FP3153	R31 F-NSF P	4	1/4	14	18	9.5	20.6	21.1	8
2FP3158	R31 F-NSF P	6	1/8	12	14	11.8	23.9	19.1	6
2FP3159	R31 F-NSF P	6	1/4	14	18	11.8	23.9	21.1	8

CENTRAL TEE, MALE, CYLINDRICAL, ROTARY R32 F-NSF PLUS

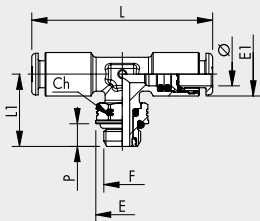

Code	Ref.	Ø	F	Ch	E	E1	L	L1	P
2FP3252	R32 F-NSF P	4	1/8	12	14	9.5	41.2	19.1	6
2FP3253	R32 F-NSF P	4	1/4	14	18	9.5	41.2	21.1	8
2FP3260	R32 F-NSF P	6	1/8	12	14	11.5	47.8	19.1	6
2FP3261	R32 F-NSF P	6	1/4	14	18	11.5	47.8	21.1	8

LATERAL TEE, MALE, CYLINDRICAL, ROTARY R38 F-NSF PLUS

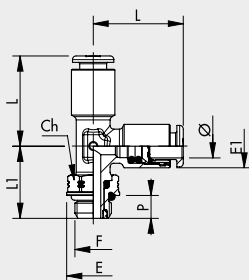

Code	Ref.	Ø	F	Ch	E	E1	L	L1	P
2FP3852	R38 F-NSF P	4	1/8	12	14	9.5	20.6	19.1	6
2FP3853	R38 F-NSF P	4	1/4	14	18	9.5	20.6	21.1	8
2FP3858	R38 F-NSF P	6	1/8	12	14	11.5	23.9	19.1	6
2FP3859	R38 F-NSF P	6	1/4	14	18	11.5	23.9	21.1	8

SERIES F-E / SERIE F-NSF FITTINGS

These fittings are made of materials suitable for use in the food industry. They can also be used with hot and cold tap water. All brass component parts undergo a clean-lead process, which consists of removing lead from the surface layer of the fitting; the gaskets are made of special FDA-approved Viton®. These fittings do not contain technopolymers, thereby avoiding problems of compatibility with detergents and other chemical agents. This choice of materials allows the fittings to be used up to 150°C, which makes them suitable for other high-temperature applications, in addition to the food industry. The threads are cylindrical and under-head O-rings provide a pneumatic seal. This avoids the need for sealants (e.g. Teflon®), which could release solid fragments during screwing and unscrewing that would contaminate the environment or the fluid. Our fittings can be screwed and unscrewed any number of times and still remain clean and pneumatically sealed. This choice of materials and treatments make these fittings suitable for use in the chemical, pharmaceutical, medical and electronics industry. The fittings are available in two series:

- Series **F-E** fittings are made of brass that undergoes a surface clean-lead process, followed by a surface coating with inter-metal alloy compound; they comply with regulatory standards applicable in Europe and other world countries for use in contact with foodstuffs or drinking water.
- Series **F-NSF** fittings are made of brass with a low-lead content ($\leq 0.1\%$) that undergoes a further surface clean-lead process in compliance with US standards, and are certified to NSF169 standards.

A standard range of fittings is available, but other designs can be developed on specific request.

SERIES F-NSF



SERIES F-E



TECHNICAL DATA		SERIES F-E	SERIES F-NSF
Threaded port		Metric: M5	
Pipe diameter	mm	G (BSP)*: 1/8 - 1/4 - 3/8 - 1/2	
Temperature range	°C	Ø 4 - Ø 6 - Ø 8 - Ø 10	
	°F	- 20 to + 150	
Pressure range	bar	- 4 to 302	
	MPa	- 0.99 to 16	
Recommended pipe		Rilsan PA 11 - Nylon 6 - Polyamide 12 - Polypropylene - PTFE	PTFE

* **Metric cylindrical threads according to ISO 262**

Cylindrical threads according to ISO 228-1, identified with a letter G. They also correspond to BSP or more precisely to BSPP designation (P stands for Parallel).

Conical threads according to ISO 7-1, identified by a letter R. They also correspond to BSP or more precisely to BSPT designation (T stands for Tapered).

COMPONENTS

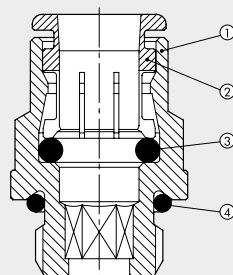

SERIES F-E

- ① Body: unleaded brass treated with environmentally-friendly intermetallic alloy
- ② Gripper: unleaded brass treated with environmentally-friendly intermetallic alloy
- ③ Seal: FDA-approved Viton®
- ④ Port seal: FDA-approved Viton®

SERIES F-NSF

- ① Body: low-lead brass ($\leq 0.1\%$)
- ② Gripper: brass (not in contact with the fluid)
- ③ Seal: FDA-approved Viton®
- ④ Port seal: FDA-approved Viton®

ADVANTAGES / CERTIFICATIONS

SERIES F-E

ADVANTAGES

Under-head O-ring

Can be screwed and unscrewed any number of times; no fragments of Teflon® or sealant will contaminate the fluid.

Corrosion resistance

The intermetallic alloy deposited on the surface and Viton® are compatible with numerous substances.

No plastic parts

CONFORMITY DECLARATIONS

- Regulation 1935/04 EU.*
- Regulation 2023/06 EU.



* Release tests performed at 50°C for 30 minutes.

SERIES F-NSF

ADVANTAGES

Under-head O-ring

Can be screwed and unscrewed any number of times; no fragments of Teflon® or sealant will contaminate the fluid.

No plastic parts

CONFORMITY DECLARATIONS

- NSF/ANSI 372 standard: drinking water system components - Lead Content.
- DM 174
- Regulation 1935/04 EU.*
- Regulation 2023/06 EU.



* Release tests performed at 50°C for 30 minutes.

CERTIFIED

- NSF/ANSI 169 standard: products in contact with food.



INSTALLING THE PIPE

Compressed air pipes must be used in compliance with some basic criteria in order to ensure long life and proper operation of the fitting:

- check that the conditions for the installation and use (e.g. temperature and fluid used) comply with the characteristics stated by the pipe manufacturer;
- check the pipe size; oversized pipes could not fit properly, undersized ones could not ensure pipe retention and air tightness.

The cut should be as accurate as possible at a right angle with the pipe axis.

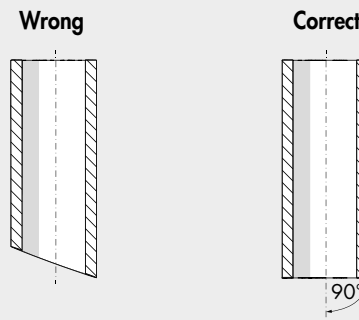

- the bending radius of the pipe installed must be as wide as possible. The fittings have been designed to ensure axial seal of the pipe; excessive curvature could considerably shorten the life of the pipe.
- the pipe must not be subjected to excessive axial stress and it must be of the right length for snugly fitting (not too long or too short).
- correct insertion of the pipe into the fitting is essential for air tightness and pipe retention. Make sure that the pipe is pushed right into the seat.
- check that the pipe does not encounter any obstacles or blockages along its way, which could cause tensile stress of the pipe in the fitting.

STRAIGHT, CYLINDRICAL, MALE R1 F

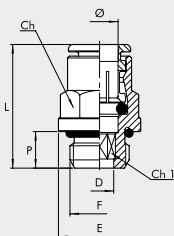

Series F-E		Series F-NSF		Ø	F	Ch	Ch1	P	L	D	E
Code	Ref.	Code	Ref.								
2F01001	R1 F-E	2F01051	R1 F-NSF	4	M5	Ø 9.9	2.5	4	21.5	2.6	9.9
2F01002	R1 F-E	2F01052	R1 F-NSF	4	1/8	11	3	6	20.5	3.1	15
2F01003	R1 F-E	2F01053	R1 F-NSF	4	1/4	12	3	8	22.5	3.1	18
2F01000	R1 F-E	2F01050	R1 F-NSF	6	M5	Ø 12.9	2.5	4	25	2.6	12.9
2F01007	R1 F-E	2F01057	R1 F-NSF	6	1/8	13	4	6	27.5	4.2	15
2F01008	R1 F-E	2F01058	R1 F-NSF	6	1/4	13	4	8	26.5	4.2	18
2F01009	R1 F-E	2F01059	R1 F-NSF	8	1/8	14	5	6	28.5	5.2	15.6
2F01010	R1 F-E	2F01060	R1 F-NSF	8	1/4	15	6	8	27	6.2	18
2F01011	R1 F-E	2F01061	R1 F-NSF	8	3/8	15	6	9	28	6.2	21
2F01012	R1 F-E	2F01062	R1 F-NSF	10	1/4	17	7	8	33.5	7.2	20
2F01013	R1 F-E	2F01063	R1 F-NSF	10	3/8	17	8	9	30.5	8.2	21
2F01022	R1 F-E	2F01072	R1 F-NSF	10	1/2	17	8	11	31.5	8.2	26

STRAIGHT, CONICAL, MALE R1C F

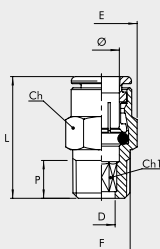

Series F-E		Series F-NSF		Ø	F	Ch	Ch1	P	L	D	E
Code	Ref.	Code	Ref.								
2F01C02	R1/C F-E	2F01C52	R1/C F-NSF	4	1/8	10	2.5	6.2	20.5	3.1	11.5
2F01C07	R1/C F-E	2F01C57	R1/C F-NSF	6	1/8	12	4	6.2	24	4.2	13.8
2F01C08	R1/C F-E	2F01C58	R1/C F-NSF	6	1/4	14	4	8.5	25.5	4.2	16
2F01C09	R1/C F-E	2F01C59	R1/C F-NSF	8	1/8	14	5	6.2	27.5	5.2	16
2F01C10	R1/C F-E	2F01C60	R1/C F-NSF	8	1/4	14	6	8.5	27.5	6.2	16
2F01C11	R1/C F-E	2F01C61	R1/C F-NSF	8	3/8	17	6	9	27	6.2	19.6
2F01C13	R1/C F-E	2F01C63	R1/C F-NSF	10	1/4	17	7	8.5	34.5	7.2	19.6
2F01C14	R1/C F-E	2F01C64	R1/C F-NSF	10	3/8	17	7	9	30.5	7.2	19.6

STRAIGHT, FEMALE R2 F

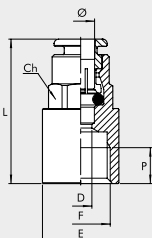

Series F-E		Series F-NSF		Ø	F	Ch	P	L	D	E
Code	Ref.	Code	Ref.							
2F02001	R2 F-E	2F02051	R2 F-NSF	4	1/8	10	7	27	3	14
2F02005	R2 F-E	2F02055	R2 F-NSF	6	1/8	13	7	30	5	15
2F02006	R2 F-E	2F02056	R2 F-NSF	6	1/4	13	8	32	5	17
2F02007	R2 F-E	2F02057	R2 F-NSF	8	1/8	14	7	30	7	17
2F02008	R2 F-E	2F02058	R2 F-NSF	8	1/4	14	8	32	7	17
2F02011	R2 F-E	2F02061	R2 F-NSF	10	1/4	17	8	35	9	20

STRAIGHT, INTERMEDIATE R3 F

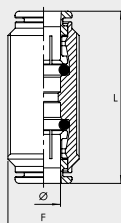

Series F-E		Series F-NSF		Ø	F	L
Code	Ref.	Code	Ref.			
2F03001	R3 F-E	2F03051	R3 F-NSF	4	M13X1	33
2F03003	R3 F-E	2F03053	R3 F-NSF	6	M15X1	40
2F03004	R3 F-E	2F03054	R3 F-NSF	8	M17X1	41
2F03005	R3 F-E	2F03055	R3 F-NSF	10	M20X1	47

ELBOW, INTERMEDIATE R4 F

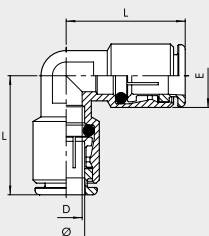

Series F-E		Series F-NSF		Ø	D	E	L
Code	Ref.	Code	Ref.				
2F04001	R4 F-E	2F04051	R4 F-NSF	4	2.5	9.5	18
2F04003	R4 F-E	2F04053	R4 F-NSF	6	4.5	13.5	22
2F04004	R4 F-E	2F04054	R4 F-NSF	8	7	14	26
2F04005	R4 F-E	2F04055	R4 F-NSF	10	9	17	30

TEE, INTERMEDIATE R5 F

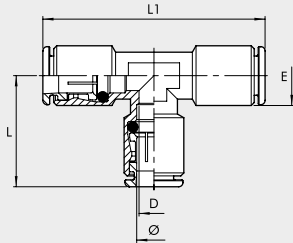

Series F-E		Series F-NSF		Ø	L	L1	D	E
Code	Ref.	Code	Ref.					
2F05001	R5 F-E	2F05051	R5 F-NSF	4	21	42	3.5	9.5
2F05003	R5 F-E	2F05053	R5 F-NSF	6	24	48	5	12.5
2F05004	R5 F-E	2F05054	R5 F-NSF	8	26	52	7	14
2F05005	R5 F-E	2F05055	R5 F-NSF	10	30	60	9	17

THREADED ADAPTER R6 F

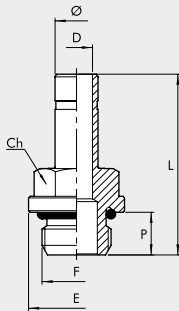

Series F-E		Series F-NSF		Ø	F	Ch	P	L	D	E
Code	Ref.	Code	Ref.							
2F06001	R6 F-E	2F06051	R6 F-NSF	4	M5	8	4	25.2	2.5	9
2F06002	R6 F-E	2F06052	R6 F-NSF	4	1/8	13	6	28.9	2.5	15
2F06003	R6 F-E	2F06053	R6 F-NSF	4	1/4	14	8	32.4	2.2	18
2F06000	R6 F-E	2F06050	R6 F-NSF	6	M5	9	4	25.7	2.7	10
2F06007	R6 F-E	2F06057	R6 F-NSF	6	1/8	13	6	29.4	4	15
2F06008	R6 F-E	2F06058	R6 F-NSF	6	1/4	14	8	32.9	4	18
2F06009	R6 F-E	2F06059	R6 F-NSF	8	1/8	13	6	30.6	5.5	15
2F06010	R6 F-E	2F06060	R6 F-NSF	8	1/4	14	8	34	6	18
2F06011	R6 F-E	2F06061	R6 F-NSF	8	3/8	17	9	35.4	6	22
2F06012	R6 F-E	2F06062	R6 F-NSF	10	1/4	14	8	35.6	7.8	18
2F06013	R6 F-E	2F06063	R6 F-NSF	10	3/8	17	9	37.1	8	22

STRAIGHT, INTERMEDIATE, BULKHEAD UNIONS R10 F

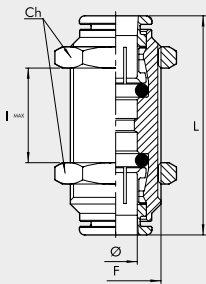

Series F-E		Series F-NSF		Ø	F	Ch	L	I MAX
Code	Ref.	Code	Ref.					
2F11001	R10 F-E	2F11051	R10 F-NSF	4	M13x1	16	33	11
2F11003	R10 F-E	2F11053	R10 F-NSF	6	M15x1	17	40	16
2F11004	R10 F-E	2F11054	R10 F-NSF	8	M17x1	20	41	19
2F11005	R10 F-E	2F11055	R10 F-NSF	10	M20x1	24	47	21

ROTARY ELBOW, MALE, CYLINDRICAL R31 F

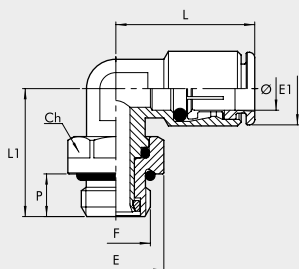

Series F-E		Series F-NSF		Ø	F	Ch	E	E1	L	L1	P
Code	Ref.	Code	Ref.								
2F31001	R31 F-E	2F31051	R31 F-NSF	4	M5	9	9	10	21	16	4
2F31002	R31 F-E	2F31052	R31 F-NSF	4	1/8	13	15	10	21	21	6
2F31003	R31 F-E	2F31053	R31 F-NSF	4	1/4	16	18	10	21	25	8
2F31007	R31 F-E	2F31057	R31 F-NSF	6	M5	9	8	11.8	24	17.5	4
2F31008	R31 F-E	2F31058	R31 F-NSF	6	1/8	13	15	12.5	24	21	6
2F31009	R31 F-E	2F31059	R31 F-NSF	6	1/4	16	18	12.5	25.5	25	8
2F31010	R31 F-E	2F31060	R31 F-NSF	8	1/8	13	15	14	26	22.5	6
2F31011	R31 F-E	2F31061	R31 F-NSF	8	1/4	16	18	14	26	25	8
2F31012	R31 F-E	2F31062	R31 F-NSF	8	3/8	19	22	14	27.5	30.5	9
2F31013	R31 F-E	2F31063	R31 F-NSF	10	1/4	16	18	16.5	30	27	8
2F31014	R31 F-E	2F31064	R31 F-NSF	10	3/8	19	22	16.5	30	30.5	9
2F31015	R31 F-E	2F31065	R31 F-NSF	10	1/2	22	26	16.5	31	32	11

ROTARY ELBOW, MALE, CONICAL R31C F

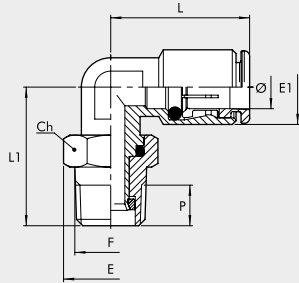

Series F-E		Series F-NSF		Ø	F	Ch	E	E1	L	L1	P
Code	Ref.	Code	Ref.								
2F31C02	R31/C F-E	2F31C52	R31/C F-NSF	4	1/8	12	13.3	10	21	22	6.2
2F31C03	R31/C F-E	2F31C53	R31/C F-NSF	4	1/4	16	17.7	10	21	27	8.5
2F31C08	R31/C F-E	2F31C58	R31/C F-NSF	6	1/8	12	13.3	11.8	24	22	6.2
2F31C09	R31/C F-E	2F31C59	R31/C F-NSF	6	1/4	16	17.7	12.5	25.5	27	8.5
2F31C10	R31/C F-E	2F31C60	R31/C F-NSF	8	1/8	12	13.3	14	26	23.5	6.2
2F31C11	R31/C F-E	2F31C61	R31/C F-NSF	8	1/4	16	17.7	14	26	27	8.5
2F31C12	R31/C F-E	2F31C62	R31/C F-NSF	8	3/8	19	22	14	27.5	31	9
2F31C13	R31/C F-E	2F31C63	R31/C F-NSF	10	1/4	16	17.7	16.5	30	29	8.5
2F31C14	R31/C F-E	2F31C64	R31/C F-NSF	10	3/8	19	22	16.5	30	31	9

CENTRAL TEE, MALE, CYLINDRICAL, ROTARY R32 F

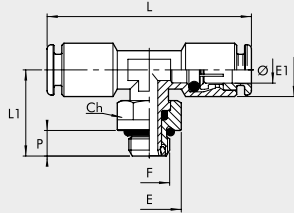

Series F-E		Series F-NSF		Ø	F	Ch	E	E1	L	L1	P
Code	Ref.	Code	Ref.								
2F32002	R32 F-E	2F32052	R32 F-NSF	4	1/8	13	15	10	41.5	21	6
2F32008	R32 F-E	2F32058	R32 F-NSF	6	1/8	13	15	12.5	47.5	21	6
2F32009	R32 F-E	2F32059	R32 F-NSF	6	1/4	16	18	12.5	50.5	25	8
2F32010	R32 F-E	2F32060	R32 F-NSF	8	1/8	13	15	14	52	22.5	6
2F32011	R32 F-E	2F32061	R32 F-NSF	8	1/4	16	18	14	52	25	8
2F32012	R32 F-E	2F32062	R32 F-NSF	8	3/8	19	22	14	56	30.5	9
2F32013	R32 F-E	2F32063	R32 F-NSF	10	1/4	16	18	16.5	60.5	27	8
2F32014	R32 F-E	2F32064	R32 F-NSF	10	3/8	19	22	16.5	60.5	30.5	9

LATERAL TEE, MALE, CYLINDRICAL, ROTARY R38 F

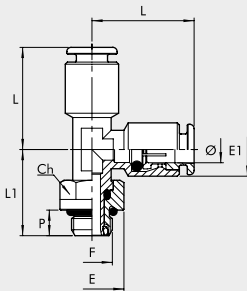

Series F-E		Series F-NSF		Ø	F	Ch	E	E1	L	L1	P
Code	Ref.	Code	Ref.								
2F38002	R38 F-E	2F38052	R38 F-NSF	4	1/8	13	15	9.5	22.5	21	6
2F38008	R38 F-E	2F38058	R38 F-NSF	6	1/8	13	15	12.5	24.5	21	6
2F38009	R38 F-E	2F38059	R38 F-NSF	6	1/4	16	18	12.5	26	25	8
2F38010	R38 F-E	2F38060	R38 F-NSF	8	1/8	13	15	14.5	27.5	22.5	6
2F38011	R38 F-E	2F38061	R38 F-NSF	8	1/4	16	18	14.5	27.5	25	8
2F38013	R38 F-E	2F38063	R38 F-NSF	10	1/4	16	18	17	31.5	27	8
2F38014	R38 F-E	2F38064	R38 F-NSF	10	3/8	19	22	17	31.5	30.5	9

ELBOW, MALE, CONICAL R39C F

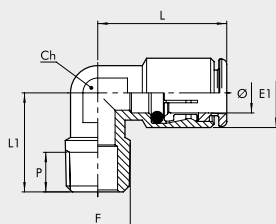

Series F-E		Series F-NSF		Ø	F	Ch	E1	L	L1	P
Code	Ref.	Code	Ref.							
2F39C02	R39/C F-E	2F39C52	R39/C F-NSF	4	1/8	10	9.5	21	16	6.2
2F39C08	R39/C F-E	2F39C58	R39/C F-NSF	6	1/8	10	11.8	23.5	16	6.2
2F39C09	R39/C F-E	2F39C59	R39/C F-NSF	6	1/4	10	11.8	24	18.5	8.5
2F39C10	R39/C F-E	2F39C60	R39/C F-NSF	8	1/8	12	14	26	17	6.2
2F39C11	R39/C F-E	2F39C61	R39/C F-NSF	8	1/4	12	14	26	20	8.5
2F39C12	R39/C F-E	2F39C62	R39/C F-NSF	8	3/8	14	14	27.5	22.5	9
2F39C13	R39/C F-E	2F39C63	R39/C F-NSF	10	1/4	14	17	30.5	22	8.5

SUMMARY FITTING SERIES A, B, C, D



● STANDARD FITTINGS SERIES A

D2.2



● COMPRESSION FITTINGS SERIES B

D2.8



● QUICK FITTINGS SERIES C

D2.11



● BANJO FITTINGS SERIES D

D2.15